

TABLE OF CONTENTS

1. INTRODUCTION.....	2
2. TESTING.....	2
3. LIMITATIONS.....	2
4. WARNINGS.....	2
5. GLOSSARY.....	3
6. UNDERSTAND YOUR KEYPAD INDICATORS.....	4
7. SUMMARY OF OPERATION.....	6
8. TELEPHONY CONTROL DIAGRAM.....	8
9. USER PROGRAMMING SUMMARY	9
10. ARMING THE SYSTEM.....	16
11. DISARMING THE SYSTEM.....	20
12. TURN ON/OFF AUTOMATION POINT.....	22
13. BYPASS ZONE.....	22
14. UN-BYPASS ZONE.....	23
15. VIEW SYSTEM TROUBLE.....	24
16. VIEW ALARM MEMORY.....	25
17. CHIME MODE.....	25
18. EMERGENCY SITUATION.....	26
19. PARTITIONING THE SYSTEM.....	28
20. ARMING A PARTITIONED SYSTEM.....	28
21. PARTITION DISARMING.....	35
22. USER PROGRAMMING MODE.....	36
23. EXIT USER PROGRAMMING MODE.....	37
24. PROGRAMMING NEW AND CHANGING EXISTING MASTER/USER CODE.....	37
25. PROGRAM SYSTEM TIMER.....	40
26. PROGRAM PARTITION 1 AUTO ARM TIMER.....	41
27. PROGRAM PARTITION 1 AUTO DISARM TIMER.....	43
28. PROGRAM PARTITION 2 AUTO ARM TIMER.....	45
29. PROGRAM PARTITION 2 AUTO DISARM TIMER.....	47
30. PROGRAM AUTO ON TIMER 1/2/3/4 FOR HOME AUTOMATION.....	49
31. PROGRAM AUTO OFF TIMER 1/2/3/4 FOR HOME AUTOMATION.....	51
32. PROGRAM PERSONAL TELEPHONE NUMBER 1/2/3/4.....	53
33. PROGRAM SYSTEM DATE.....	55
34. PROGRAM SECURITY AND HOME AUTOMATION TIMER SCHEDULE.....	55
35. TESTING THE SYSTEM.....	56
36. SYSTEM INFORMATION.....	58

INTRODUCTION

The **BLUGUARD** Control Panel is designed for simple operation yet provides the maximum protection for you. Please read this manual carefully and follow the instructions contained in this book. Fill in the system information page and store this manual in a safe place for future reference.

Your security system consists of a main control panel, one or more keypads and home automation (HA) modules, various sensors and detectors. An enclosure will contain the control panel, which includes the system electronics and standby battery.

TESTING

To ensure that your system is functioning, it is important that you test your system weekly. Please refer to testing procedures section in this manual. If your system does not function properly, please contact your system installer for services. There is normally no reason for anyone other than the installer or service professional to have access to the control panel.

LIMITATIONS

Even though BLUGUARD is an advanced security system, it does not 100% guarantee the protection against burglary, fire or other losses. Any alarm system whether commercial or residential is subjected to compromise or failure-to-warn for a variety of reasons. These include:



- Intruders may gain access through unprotected openings or have the technical sophistication to bypass an alarm sensor or disconnect an alarm warning device.
- Intrusion detectors, smoke detectors and many sensing devices will not operate without power. Devices powered by AC will not work if there is no AC power supply for any reason and the back-up battery is missing, dead or improperly installed.
- Alarm warning devices such as sirens may not alert people or wake up sleepers if they are located on the other side of closed or partly closed doors.
- Telephone line needed to transmit alarm events from the premise to a central monitoring station may be out or temporary out of service. Telephone line is subject to compromise by sophisticated method of attack.
- Smoke detector used in conjunction with the alarm system may not sense fire that start from where smoke cannot reach the detector such as wall, roof or the other side of the doors. Smoke detector also may not sense a fire on another level of the residence or building. In general, detectors may not always warn you about fire caused by carelessness and safety hazards like smoking, violent explosions, escaping gas, improper storage of flammable material, overloaded electrical circuits, children playing with matches.
- The most common cause of an alarm system not functioning properly when an intrusion or fire occurs is inadequate maintenance. Therefore, your system should be tested weekly to ensure all detectors or sensors are working properly.
- Installing an alarm system may make you eligible for lower insurance rates but an alarm system is not a substitute for insurance. Homeowners, property owners and renters should continue to insure their lives and properties.

WARNINGS

- **A readily accessible disconnect device shall be incorporated external to the equipment when installation.**
- No operator's replaceable batteries provided.
- The caution of replacement of battery provided in installation instructions for SERVICE PERSON.
- **CAUTION: RISK OF EXPLOSION IF BATTERY IS REPLACED BY INCORRECT TYPE.**
- **CAUTION: DISPOSE OF USED BATTERIES ACCORDING TO THE INSTRUCTIONS.**
- The installation instructions require the **external protective earthing green/yellow wire must be at least 0.75mm²/18AWG complying with table 3B.**

Note: All information is subject to changes without prior notice.

GLOSSARY

Alarm Memory 	<p>This is the history of the most recent violations that occurred the last time when an alarm was triggered.</p>
Arm 	<p>To set the system into the ARMED mode. In this mode, a zone violation will activate an alarm condition. If the system is programmed accordingly, it will cause a reporting code to be sent to the central monitoring station.</p>
Bypass	<p>To deactivate zone. When the panel is ARMED, violation of a bypassed zone will be ignored.</p>
Chime	<p>A short beep sound from the keypad to indicate a zone is violated.</p>
Day Arm	<p>Instant arming that allows for certain preprogrammed, DAY STAY zones to be violated while the system is armed. In this mode, an ENTRY delay time will be given to the user to disarm using the keypad after entering the armed premises.</p>
Day Stay Zone	<p>Zones that are bypassed automatically when the system is DAY ARMED.</p>
Disarm	<p>To deactivate the system. FIRE, PANIC and MEDICAL remain active while the system is disarmed.</p>
Duress Code	<p>An ambush code which will disarm the system and simultaneously send a silent distress signal to the central monitoring station.</p>
Entry/Exit Zone	<p>A zone with programmable delay time will allow user to exit the premises after arming the system and disarm by using the keypad after entering the armed premises. This zone is generally the last exit point and the first entry point of the building, i.e. the front door of a house.</p>
Follower Zone	<p>A zone that may be temporary violated during exit delay period or after the first violation of an ENTRY/EXIT zone. This allows the user access to disarm the system. A FOLLOWER zone will behave as an instant zone if it is violated prior to the violation of an ENTRY/EXIT zone.</p>
Force Arm	<p>Arming with exit delay that allows for certain violated zones to be bypassed temporary. When the violated zones resume, these zones will be protected. There is an ENTRY delay time in this arming mode.</p>
Home Automation (HA)	<p>Optional system expander module that allows you to control different light and appliances from any keypad, remote telephone, cellular phone. It can also be programmed to turn on/off light at certain time daily or during alarm condition.</p>
Instant Zone	<p>When the system is armed, any violation of an instant zone will immediately cause an alarm condition to be registered.</p>
Master Code	<p>Master code is a 4-digit personal identification number that allows you to enter certain programming mode, arm or disarm the system and remotely control the system via telephone line.</p>
Night Arm	<p>Instant arming that allows for certain preprogrammed, NIGHT STAY zones to be violated while the system is armed. In this mode, there is no ENTRY delay time for the user.</p>
Night Stay Zone	<p>Zones that are bypassed automatically when the system is NIGHT ARMED.</p>
Partitioning	<p>A partitioned system is a single physical security system that provides independent areas of protection intended for use by independent users.</p>
Remote Control Arm	<p>Arming with a momentary or latch remote control module. In this mode, it allows certain violated zones to be bypassed temporary. When the violated zones resume, the zone will be protected. There is an ENTRY and EXIT delay time in this arming mode.</p>
User Code	<p>User code is a 4-digit personal identification number that allows you to arm or disarm the system.</p>
Zone	<p>A specific area of your premises guarded by sensors, which detect violations of that area.</p>

UNDERSTAND YOUR KEYPAD INDICATORS (LED)

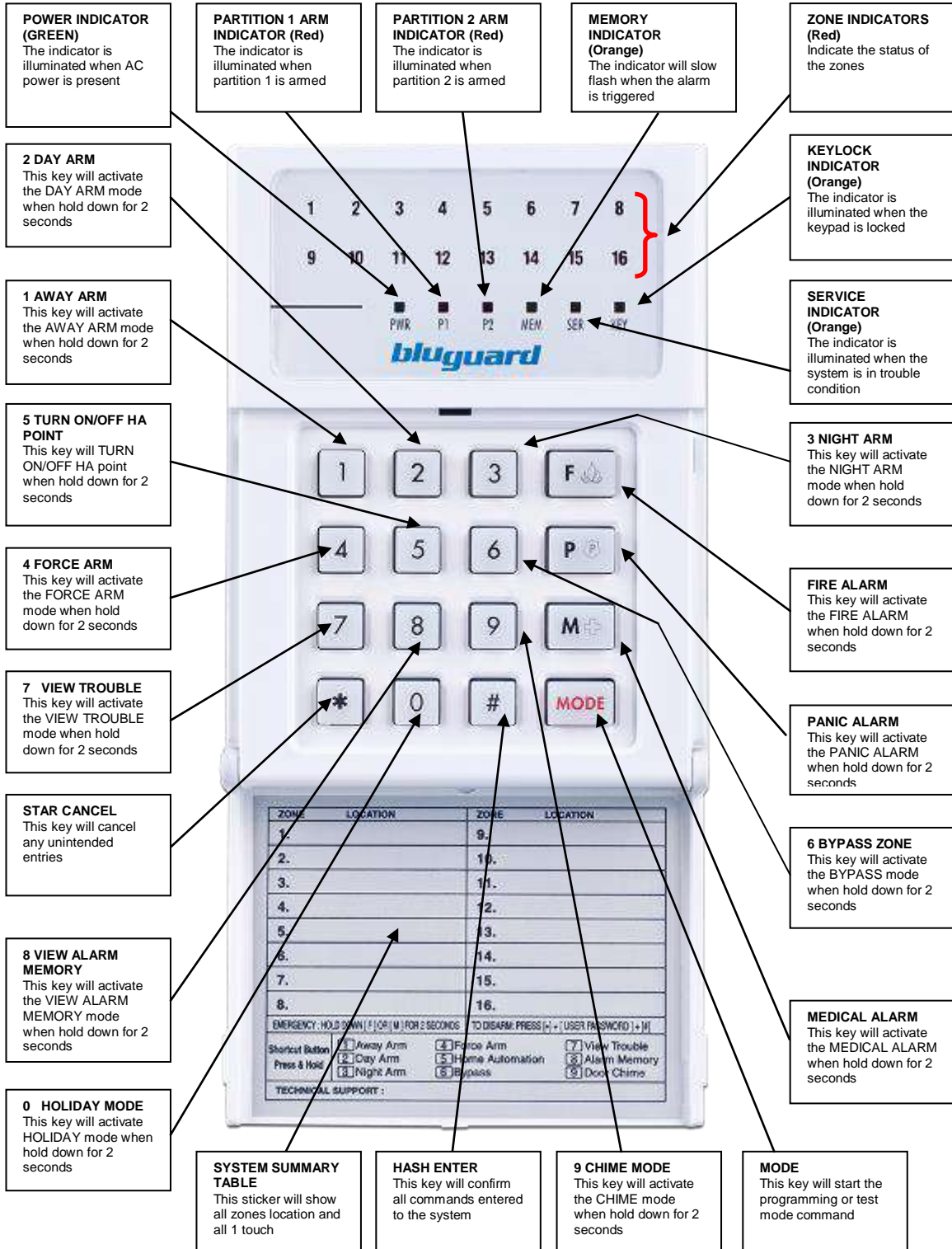

UNDERSTAND YOUR KEYPAD INDICATORS (LCD)

PARTITION 1 ARMED ICON
The armed icon is displayed when partition 1 is armed

PARTITION 2 ARMED ICON
The armed icon is displayed when partition 2 is armed

SERVICE INDICATOR
The icon is displayed when the system is in trouble condition

MEMORY INDICATOR
The icon will be blinking when the alarm is triggered

MUTE KEYPAD SOUND
The icon will be displayed when the keypad is muted.

POWER INDICATOR
The icon is displayed when AC power is present

KEYLOCK INDICATOR
The icon is displayed when the keypad is locked

2 DAY ARM
This key will activate the DAY ARM mode when hold down for 2 seconds

CLOCK
Display Clock

1 AWAY ARM
This key will activate the AWAY ARM mode when hold down for 2 seconds

ZONE INDICATORS
Indicate the status of the zones

5 TURN ON/OFF HA POINT
This key will TURN ON/OFF HA point when hold down for 2 seconds

3 NIGHT ARM
This key will activate the NIGHT ARM mode when hold down for 2 seconds

Fire emergency
This key will activate The fire emergency Warning

4 FORCE ARM
This key will activate the FORCE ARM mode when hold down for 2 seconds

Scroll Up
This key will scroll up for manual & Instructions

7 VIEW TROUBLE
This key will activate the VIEW TROUBLE mode when hold down for 2 seconds

Scroll Down
This key will scroll Down for manual & Instructions

STAR CANCEL
This key will cancel any unintended entries Or Exit to the main menu

6 BYPASS ZONE
This key will activate the BYPASS mode when hold down for 2 seconds

8 VIEW ALARM MEMORY
This key will activate the VIEW ALARM MEMORY mode when hold down for 2 seconds

0 HOLIDAY MODE
This key will activate HOLIDAY mode when hold down for 2 seconds

HASH ENTER
This key will confirm all commands entered to the system

9 CHIME MODE
This key will activate the CHIME mode when hold down for 2 seconds

MODE
This key will start the programming or test mode command

ZONE	LOCATION	ZONE	LOCATION
1.		9.	
2.		10.	
3.		11.	
4.		12.	
5.		13.	
6.		14.	
7.		15.	
8.		16.	

TO ARM (DISARM): PRESS * + (USER PASSWORD) + [0]	EMERGENCY - FIRE : HOLD DOWN [F] FOR 2 SECONDS PANIC : PRESS [MODE] (4) FOR MEDICAL : PRESS [MODE] (4) FOR
Shortcut/Button Press & Hold	[1] Away Arm [2] Force Arm [3] View Trouble [4] Day Arm [5] Home Automation [6] Alarm Memory [7] Night Arm [8] Bypass [9] Door Status

TECHNICAL SUPPORT :

SUMMARY OF OPERATION

Intelligent Disarm	[4-digit User Code] + [#]
Intelligent Arming	[4-digit User Code] + [#]
Away Arm	Hold down [1] for 2 seconds
Day Arm	Hold down [2] for 2 seconds
Night Arm	Hold down [3] for 2 seconds
Force Arm	Hold down [4] for 2 seconds
Turn On/Off Home Automation Point	Hold down [5] for 2 seconds + [HA point number 1 to 16] + [#]
Bypass Security Zone	Hold down [6] for 2 seconds + [Zone number 1 to 16] + [#]
View System Trouble	Hold down [7] for 2 seconds
View Alarm Memory	Hold down [8] for 2 seconds
Program Chime Zone	Hold down [9] for 2 seconds + [Zone number 1 to 16] + [#]
Holiday Mode Arming	Hold down [0] for 2 seconds
Activate Fire Alarm	Hold down [F] for 2 seconds
Activate Panic Alarm	LED: Hold down [P] for 2 seconds LCD: Press [MODE] + [8] + [#]
Activate Medical Alarm	LED: Hold down [M] for 2 seconds LCD: Press [MODE] + [9] + [#]
Turn On/Off Keypad Buzzer	LED: Hold down [MODE] for 2 seconds LCD: Press [MODE] + [6] + [#]
View Event Log	LCD: Press [MODE] + [MODE] + [#]
<p>Remark: To enter zone number more than 9, press button [F] to represent the ten's digit. e.g. To enter zone number 15, press [F] + [5].</p>	

SUMMARY OF OPERATION

PARTITION SYSTEM ENABLED	
Intelligent Disarm	[4-digit User Code] + [#] + [Partition 1] or [Partition 2]
Intelligent Arming	[4-digit User Code] + [#] + [Partition 1] or [Partition 2]
Away Arm	Hold down [1] for 2 seconds + [Partition 1] or [Partition 2]
Day Arm	Hold down [2] for 2 seconds + [Partition 1] or [Partition 2]
Night Arm	Hold down [3] for 2 seconds + [Partition 1] or [Partition 2]
Force Arm	Hold down [4] for 2 seconds + [Partition 1] or [Partition 2]
Holiday Mode Arming	Hold down [0] for 2 seconds + [Partition 1] or [Partition 2]
TESTING THE SYSTEM	
Sensor Walk Test	LED: [MODE] + [1] + [#] LCD: [MODE] + [1] + [#] OR MENU ⇒ System Test ⇒ Walk Test
CMS Reporting Test	LED: [MODE] + [2] + [#] LCD: [MODE] + [2] + [#] OR MENU ⇒ System Test ⇒ CMS Test
Siren Test	LED: [MODE] + [3] + [#] LCD: [MODE] + [3] + [#] OR MENU ⇒ System Test ⇒ Siren Test
Strobe Light Test	LED: [MODE] + [4] + [#] LCD: [MODE] + [4] + [#] OR MENU ⇒ System Test ⇒ Strobe Test
Battery Test	LED: [MODE] + [5] + [#] LCD: [MODE] + [5] + [#] OR MENU ⇒ System Test ⇒ Battery Test

TELEPHONY CONTROL DIAGRAM

Call In to System:

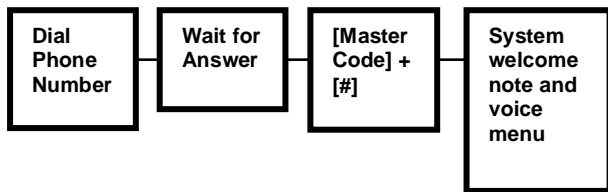

System Call Out:

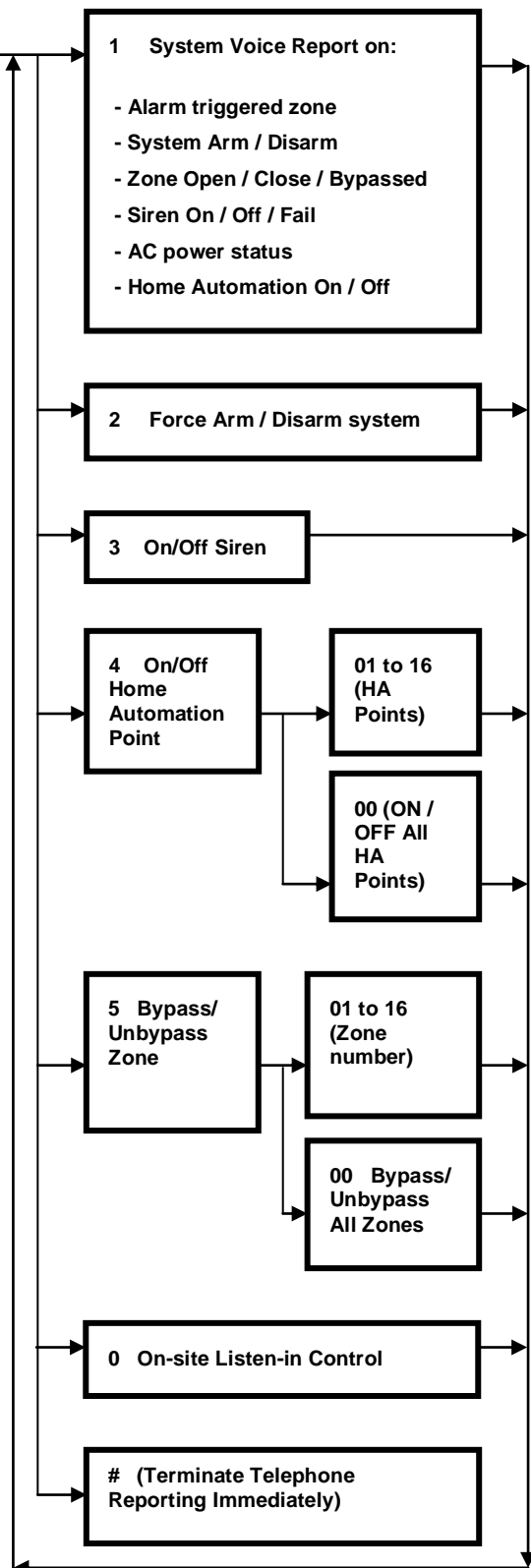
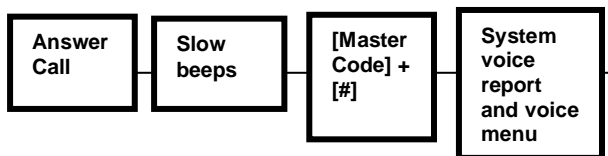

Remark:

The system will automatically cut off telephone line if the user does not key in any number for more than 60 seconds or key in wrong master code more than 3 times.

USER PROGRAMMING SUMMARY DIAGRAM (LED)

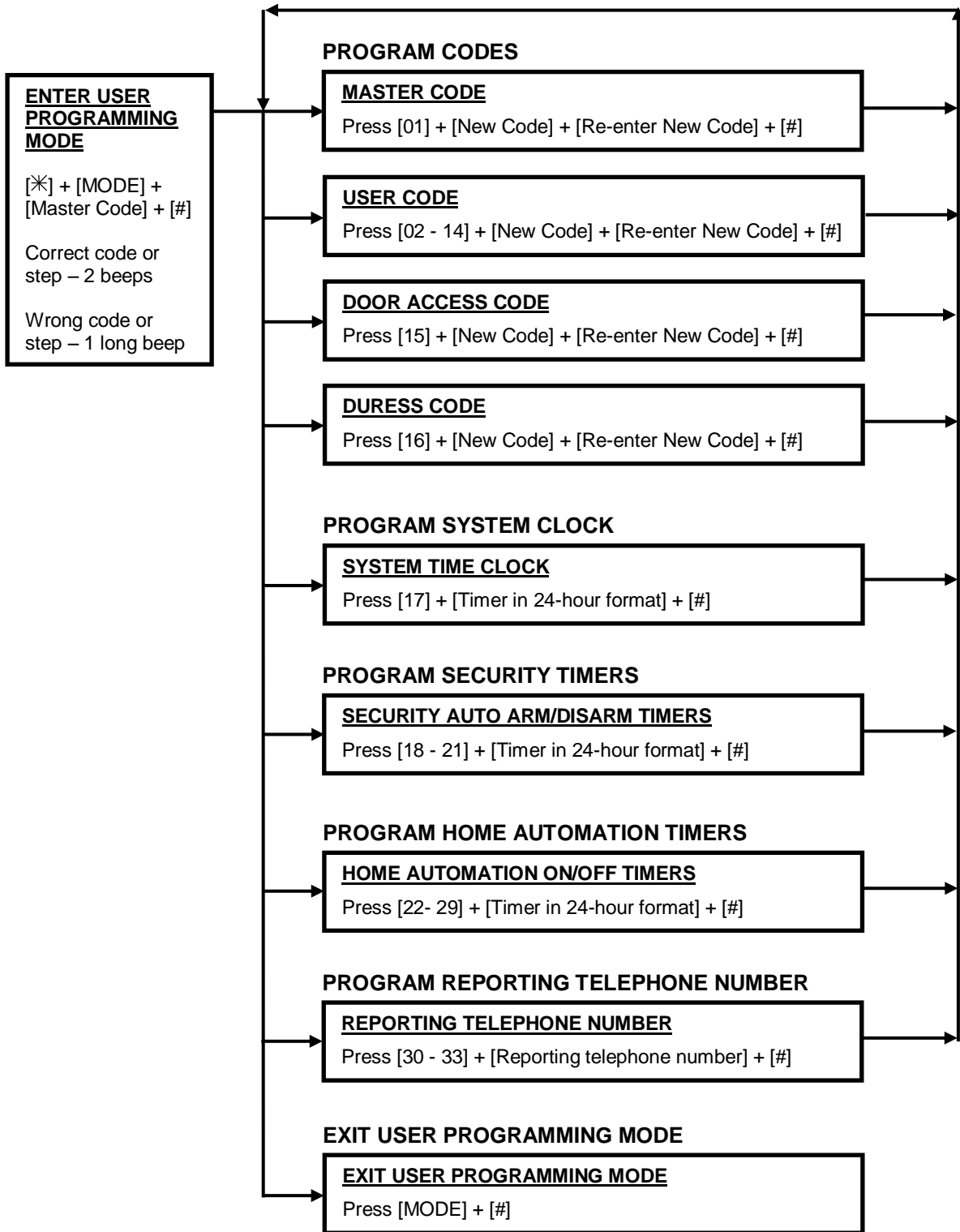

USER PROGRAMMING SUMMARY TABLE (LED)

Enter User Programming Mode	[*] + [MODE] + [4-digit Master Code] + [#]
Exit User Programming Mode	[MODE] + [#]
Program New or Change Existing	
Master Code 01	[01] + [New Master Code] + [Re-enter New Master Code] + [#]
Program New or Change Existing	
User Code 2	[02] + [New User Code] + [Re-enter New User Code] + [#]
User Code 3	[03] + [New User Code] + [Re-enter New User Code] + [#]
User Code 4	[04] + [New User Code] + [Re-enter New User Code] + [#]
User Code 5	[05] + [New User Code] + [Re-enter New User Code] + [#]
User Code 6	[06] + [New User Code] + [Re-enter New User Code] + [#]
User Code 7	[07] + [New User Code] + [Re-enter New User Code] + [#]
User Code 8	[08] + [New User Code] + [Re-enter New User Code] + [#]
User Code 9	[09] + [New User Code] + [Re-enter New User Code] + [#]
User Code 10	[10] + [New User Code] + [Re-enter New User Code] + [#]
User Code 11	[11] + [New User Code] + [Re-enter New User Code] + [#]
User Code 12	[12] + [New User Code] + [Re-enter New User Code] + [#]
User Code 13	[13] + [New User Code] + [Re-enter New User Code] + [#]
User Code 14	[14] + [New User Code] + [Re-enter New User Code] + [#]
Program New or Change Existing	
Door Access Code	[15] + [New User Code] + [Re-enter New User Code] + [#]
Program New or Change Existing	
Duress Code	[16] + [New User Code] + [Re-enter New User Code] + [#]
Remark: <ol style="list-style-type: none"> All programmed codes must be unique from each other. Duplicate code will be rejected during user programming mode. Door Access Code is not a security code. This code cannot ARM/DISARM the security system. Door Access Code is a special code programmed to control your door access system. 	

USER PROGRAMMING SUMMARY TABLE (LED)

3. Master code, User Code 2, User Code 3 and User Code 4 are telephone remote access codes. These codes can ARM/DISARM the security system via local keypad or via telephone remote access.	
Program System Timer	
System Clock	[17] + [Current Time in 24-hour Format] + [#]
Program Security Timers	
Partition 1 Auto Arm Timer	[18] + [Partition 1 Security Auto ARM Timer] + [#]
Partition 1 Auto Disarm Timer	[19] + [Partition 1 Security Auto DISARM Timer] + [#]
Partition 2 Auto Arm Timer	[20] + [Partition 2 Security Auto ARM Timer] + [#]
Partition 2 Auto Disarm Timer	[21] + [Partition 2 Security Auto DISARM Timer] + [#]
Program Home Automation Timers	
Home Automation Auto ON Timer 1	[22] + [Home Automation Auto ON Timer 1] + [#]
Home Automation Auto OFF Timer 1	[23] + [Home Automation Auto OFF Timer 1] + [#]
Home Automation Auto ON Timer 2	[24] + [Home Automation Auto ON Timer 2] + [#]
Home Automation Auto OFF Timer 2	[25] + [Home Automation Auto OFF Timer 2] + [#]
Home Automation Auto ON Timer 3	[26] + [Home Automation Auto ON Timer 3] + [#]
Home Automation Auto OFF Timer 3	[27] + [Home Automation Auto OFF Timer 3] + [#]
Home Automation Auto ON Timer 4	[28] + [Home Automation Auto ON Timer 4] + [#]
Home Automation Auto OFF Timer 4	[29] + [Home Automation Auto OFF Timer 4] + [#]
Remark: All programmed timer must be in 24-hour format e.g. 7 am = 07 00, 8 pm = 20 00.	
Program Reporting Telephone Number	
Telephone Number 1	[30] + [Reporting Telephone Number 1] + [#]
Telephone Number 2	[31] + [Reporting Telephone Number 2] + [#]
Telephone Number 3	[32] + [Reporting Telephone Number 3] + [#]
Telephone Number 4	[33] + [Reporting Telephone Number 4] + [#]
Remark: Button "P" on the keypad is representing a "PAUSE" key of 5 seconds duration, Button "M" on the keypad is representing a "*" key of telephone system.	

USER PROGRAMMING SUMMARY DIAGRAM (LCD)

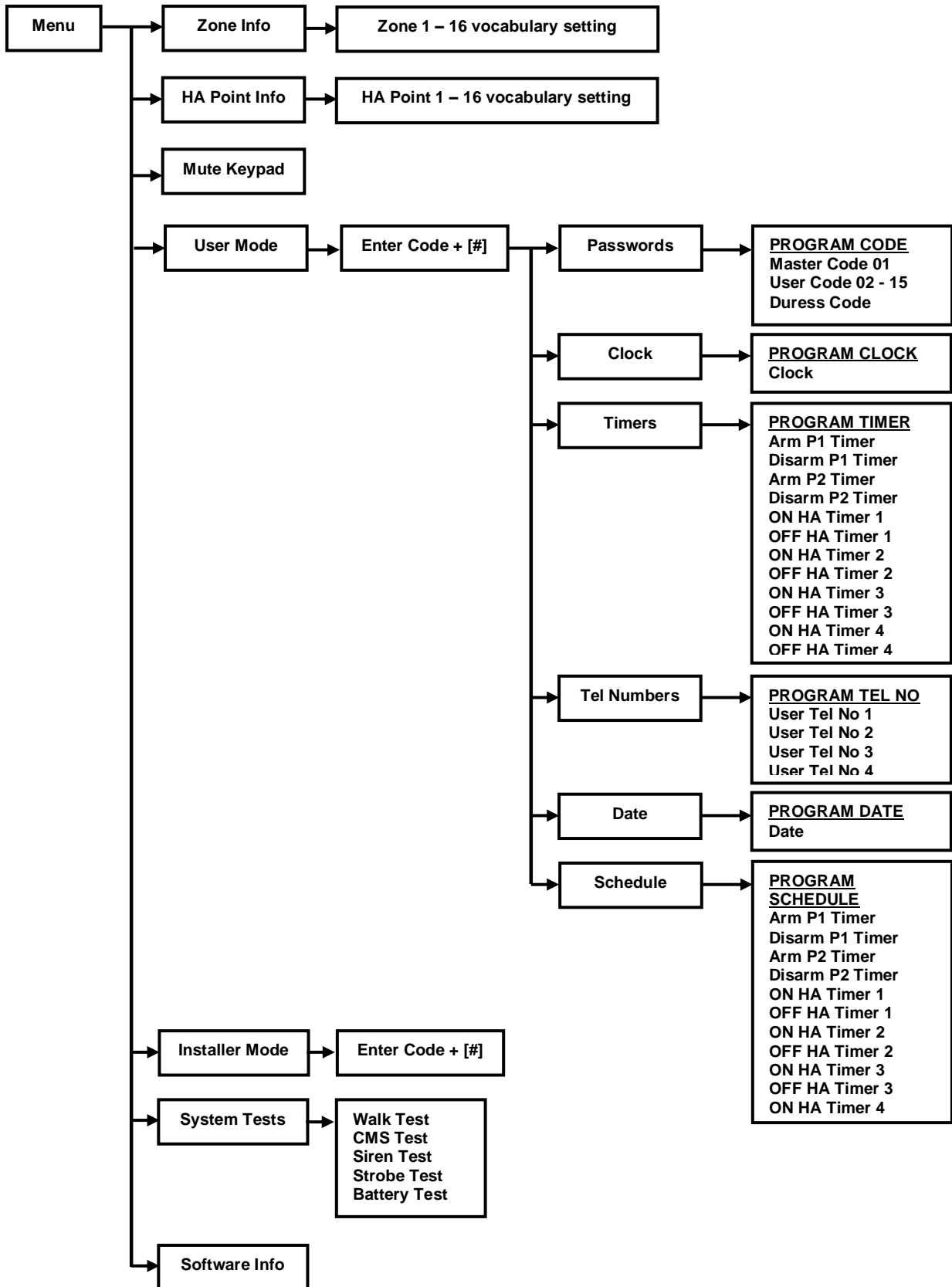

USER PROGRAMMING SUMMARY TABLE (LCD)

Enter User Programming Mode : [*] + [MODE] + [4-digit Master Code] + [#] / Enter from LCD Menu			
Exit User Programming Mode : [*] / Exit from LCD Menu			
Program New or Change Existing			
Password	Master Code 01	Key in [New User Code] + [#]	[Re-confirm New User Code] + [#]
	User Code 02	Key in [New User Code] + [#]	[Re-confirm New User Code] + [#]
	User Code 03	Key in [New User Code] + [#]	[Re-confirm New User Code] + [#]
	User Code 04	Key in [New User Code] + [#]	[Re-confirm New User Code] + [#]
	User Code 05	Key in [New User Code] + [#]	[Re-confirm New User Code] + [#]
	User Code 06	Key in [New User Code] + [#]	[Re-confirm New User Code] + [#]
	User Code 07	Key in [New User Code] + [#]	[Re-confirm New User Code] + [#]
	User Code 08	Key in [New User Code] + [#]	[Re-confirm New User Code] + [#]
	User Code 09	Key in [New User Code] + [#]	[Re-confirm New User Code] + [#]
	User Code 10	Key in [New User Code] + [#]	[Re-confirm New User Code] + [#]
	User Code 11	Key in [New User Code] + [#]	[Re-confirm New User Code] + [#]
	User Code 12	Key in [New User Code] + [#]	[Re-confirm New User Code] + [#]
	User Code 13	Key in [New User Code] + [#]	[Re-confirm New User Code] + [#]
	User Code 14	Key in [New User Code] + [#]	[Re-confirm New User Code] + [#]
	User Code 15 (Door Access Code)	Key in [New User Code] + [#]	[Re-confirm New User Code] + [#]
Duress Code	Key in [New User Code] + [#]	[Re-confirm New User Code] + [#]	
Remark:			
<ol style="list-style-type: none"> 1. User code 15 (Door Access Code) is not a security code. This code cannot ARM/DISARM the security system. User code 15 is a special code programmed to control your access system. 2. Master code, User Code 2, User Code 3 and User Code 4 are telephone remote access codes. These codes can ARM/DISARM the security system via local keypad or via telephone remote access. 			
Program System Timer			
Clock	Real Time Clock	Key in time [0000 to 2359] + [#]	[F # to erase the previous setting]

USER PROGRAMMING SUMMARY TABLE (LCD)

Program Security Timers			
Timers	Arm P1 Timer	Key in time [0000 to 2359] + [#]	<i>[F# to erase the previous setting]</i>
	Disarm P1 Timer	Key in time [0000 to 2359] + [#]	<i>[F# to erase the previous setting]</i>
	Arm P2 Timer	Key in time [0000 to 2359] + [#]	<i>[F# to erase the previous setting]</i>
	Disarm P2 Timer	Key in time [0000 to 2359] + [#]	<i>[F# to erase the previous setting]</i>
Program Home Automation Timers			
Timers	ON HA Timer 1	Key in time [0000 to 2359] + [#]	<i>[F# to erase the previous setting]</i>
	OFF HA Timer 1	Key in time [0000 to 2359] + [#]	<i>[F# to erase the previous setting]</i>
	ON HA Timer 2	Key in time [0000 to 2359] + [#]	<i>[F# to erase the previous setting]</i>
	OFF HA Timer 2	Key in time [0000 to 2359] + [#]	<i>[F# to erase the previous setting]</i>
	ON HA Timer 3	Key in time [0000 to 2359] + [#]	<i>[F# to erase the previous setting]</i>
	OFF HA Timer 3	Key in time [0000 to 2359] + [#]	<i>[F# to erase the previous setting]</i>
	ON HA Timer 4	Key in time [0000 to 2359] + [#]	<i>[F# to erase the previous setting]</i>
	OFF HA Timer 4	Key in time [0000 to 2359] + [#]	<i>[F# to erase the previous setting]</i>
Remark: All programmed timer must be in 24-hour format e.g. 7 am = 07 00, 8 pm = 20 00.			
Program Reporting Telephone Numbers			
Tel No's	User Tel No 1	Key in [14 digit Tel No.] + [#]	<i>[F to erase the previous setting]</i>
	User Tel No 2	Key in [14 digit Tel No.] + [#]	<i>[F to erase the previous setting]</i>
	User Tel No 3	Key in [14 digit Tel No.] + [#]	<i>[F to erase the previous setting]</i>
	User Tel No 4	Key in [14 digit Tel No.] + [#]	<i>[F to erase the previous setting]</i>
Remark: Button “▲” on the keypad is representing a “PAUSE” key of 5 seconds duration, Button “▼” on the keypad is representing a “*” key of telephone system.			
Program System Date			
Date	Current Date	[DD/MM/YY] + [#]	<i>[F # to erase the previous setting]</i>

USER PROGRAMMING SUMMARY TABLE (LCD)

Program Security and Home Automation Timers Schedule			
Schedule	Arm P1 Timer	Press 1 for Monday	1 2 3 4 5 6 7
	Disarm P1 Timer	Press 2 for Tuesday	1 2 3 4 5 6 7
	Arm P2 Timer	Press 3 for Wednesday	1 2 3 4 5 6 7
	Disarm P2 Timer	Press 4 for Thursday	1 2 3 4 5 6 7
	ON HA Timer 1	Press 5 for Friday	1 2 3 4 5 6 7
	OFF HA Timer 1	Press 6 for Saturday	1 2 3 4 5 6 7
	ON HA Timer 2	Press 7 for Sunday	1 2 3 4 5 6 7
	OFF HA Timer 2		1 2 3 4 5 6 7
	ON HA Timer 3		1 2 3 4 5 6 7
	OFF HA Timer 3		1 2 3 4 5 6 7
	ON HA Timer 4		1 2 3 4 5 6 7
	OFF HA Timer 4		1 2 3 4 5 6 7

ARMING THE SYSTEM

There are various options for arming the system

- a. **Partition Arming**
- b. **Away Arming**
- c. **Day Arming**
- d. **Night Arming**
- e. **Force Arming**
- f. **Holiday Arming**
- g. **Remote Control Arming**
- h. **Timer Auto Arming**
- i. **Telephone Remote Arming**

For information on how to ARM Partition system, please refer to PARTITIONING THE SYSTEM at page 28.

AWAY ARMING

[*] + [USER CODE] + [#]

(Leave via ENTRY/EXIT Zone)

1. Ensure that all zone indicators are distinguished; if not, check that all protected premises are closed.
2. Press the **[*]** key to cancel any unintended entries.
3. Enter a valid 4-digit **[USER CODE]**. If you enter any mistakes, press **[*]** key and re-enter the code followed by **[#]** key to confirm you command.
4. **P1** indicator will illuminate.



icon will be displayed

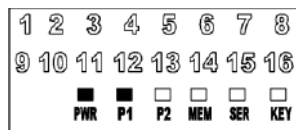

An **EXIT** delay countdown timer will be shown at the top right temporarily replace the clock.

5. The keypad audible indicator will sound on and off for the duration of the **EXIT** delay.
6. Any bypassed zones will be shown by the flashing zone indicators.
7. Leave the premises only via the **EXIT/ENTRY** zone.
8. During AWAY arming, the telephone line will be supervised hourly. If the telephone line is disconnected, a new trouble condition will be registered (please refer to View System Trouble).
9. User will be given an **ENTRY** delay time to disarm the system when enter the protected premises via **ENTRY/EXIT** zone.
10. It is also possible to AWAY arm by simply enter and hold down **[1]** key for 2 seconds.

[1]

(Press and hold down for 2 seconds)

DAY ARMING

[2]

(Press and hold down for 2 seconds)

1. This arming mode is ideal for **DAY** time arming with user still remains in the protected premises.
2. In this mode, the system will be armed instantly with certain preprogrammed, **DAY STAY** zones bypassed automatically.
3. Ensure that all zone indicators are distinguished; if not, check that all protected premises are closed.
4. DO NOT open the **ENTRY/EXIT** zone.
5. Enter and hold down **[2]** key for 2 seconds.
6. **P1** indicator will illuminate.



icon will be displayed

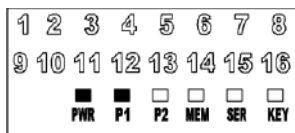

7. The keypad audible indicator will sound 2 beeps to confirm the arming.
8. Any **DAY STAY** zones will be automatically bypassed (shown by flashing zone indicators).
9. User will be given an **ENTRY** delay time to **DISARM** the system when enter the protected premises via **ENTRY/EXIT** zone.

NIGHT ARMING

[3]

(Press and hold down for 2 seconds)

1. This arming mode is ideal for **NIGHT** time arming with user still remains in the protected premises.
2. In this mode, the system will be armed instantly with certain preprogrammed, **NIGHT STAY** zones bypassed automatically.
3. Ensure that all zone indicators are distinguished; if not, check that all protected premises are closed.
4. DO NOT open the **ENTRY/EXIT** zone.
5. Enter and hold down **[3]** key for 2 seconds.
6. **P1** indicator will illuminate.



icon will be displayed

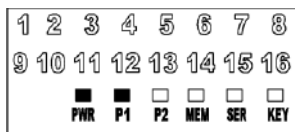

7. The keypad audible indicator will sound 2 beeps to confirm the arming.
8. Any **NIGHT STAY** zones will be automatically bypassed (shown by flashing zone indicators).
9. There is no **ENTRY** delay in this arming mode. Any violation on the active zones will trigger the system instantly.

FORCE ARMING

[4]

(Press and hold down for 2 seconds)

1. In this mode, the system will be armed with **EXIT** delay time which allows certain violated zones to be bypassed temporary. When the violated zones resume, the zone will be protected again.
2. Enter and hold down **[4]** key for 2 seconds.
3. **P1** indicator will illuminate.

 icon will be displayed

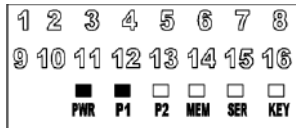

An **EXIT** delay countdown timer will be shown at the top right temporarily replace the clock.

4. The keypad audible indicator will sound on and off for the duration of the **EXIT** delay.
5. Any bypassed zones will be shown by the flashing zone indicators
6. User will be given an **ENTRY** delay time to DISARM the system when enter the protected premises via **ENTRY/EXIT** zone.

HOLIDAY ARMING

[0]

(Press and hold down for 2 seconds)

1. This arming mode is ideal for long away occasion (holiday).
2. In this mode, the system will be **AWAY** armed. Home Automation points will be random ON/OFF every hour to simulate occupancy from 7pm to 1am.
3. Ensure that all zone indicators are distinguished; if not, check that all protected premises are closed.
4. Enter and hold down **[0]** key for 2 seconds.
5. **P1** indicator will illuminate.

 icon will be displayed

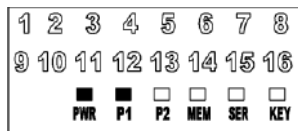

An **EXIT** delay countdown timer will be shown at the top right temporarily replace the clock.

6. The keypad audible indicator will sound on and off for the duration of the **EXIT** delay.
7. Any bypassed zones will be shown by the flashing zone indicators.
8. Leave the premises only via the **EXIT/ENTRY** zone.
9. User will be given an **ENTRY** delay time to disarm the system when enter the protected premises via **ENTRY/EXIT** zone.

10. After disarming, Home Automation random ON/OFF function will be deactivated and the system will resume to normal Home Automation ON/OFF timers setting.

REMOTE CONTROL ARMING

1. This arming mode is ideal for remote control unit or key-switch arming.
2. The system will arm in **AWAY** arming mode.
3. The system will be armed with **EXIT** delay time which allows certain violated zones to be bypassed temporary. When the violated zones resume, the zone will be protected again.
4. Press the remote control button or twist and release the key-switch.
5. The system will be armed instantly. Leave the premises via **ENTRY/EXIT** zone.
6. **P1** indicator will illuminate.



icon will be displayed

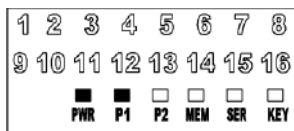

An **EXIT** delay countdown timer will be shown at the top right temporarily replace the clock.

7. The keypad audible indicator will sound 2 beeps to confirm the arming.
8. If programmed to do so, the siren will sound briefly for this remote control arming (please refer to Installer Programming Section – System Option Setting).
9. User will be given an **ENTRY** delay time to DISARM the system when enter the protected premises via **ENTRY/EXIT** zone.

TIMER AUTO ARMING

1. Your system can be programmed to automatically **ARM** itself according to a programmed schedule.
2. This arming mode will automatically turn to **FORCE ARM** mode when the system timer reaches the preset **AUTO ARM** time.
3. Please refer to User Programming Section – Program Auto ARM Timer.

TELEPHONE REMOTE ARMING

1. Your system can be remotely ARM from outside the house through any normal DTMF telephone or GSM hand phone.
2. This arming mode will automatically turn to **FORCE ARM** mode when the user enter a correct Master Code through Telephone or hand phone.
3. Please refer to Telephony Control Diagram at page 8.

DISARMING THE SYSTEM

There are various options for disarming the system:

- a. Partition Disarming
- b. Keypad Disarming
- c. Remote Control Disarming
- d. Timer Auto Disarming
- e. Telephone Remote Disarm

For information on how to DISARM Partition system, please refer to PARTITION DISARMING at page 35.

KEYPAD DISARMING

[USER CODE] + [#]

1. To disarm the system, enter a valid 4-digit [USER CODE] followed by [#] key before expiry of the entry delay time.
2. Enter the premises through a designated ENTRY/EXIT zone; entering via other zones will trigger an alarm instantly.
3. The ENTRY delay begins once the ENTRY zone is violated.
4. The keypad audible indicator will sound for the duration of the ENTRY delay to indicate that a valid user code is required.
5. If the P1 indicator remains illuminated, an error has been made while entering the user code. Press [*] key and re-enter the user code.

If the  icon remains displayed, an error has been made while entering the user code. Press [*] key and re-enter the user code.

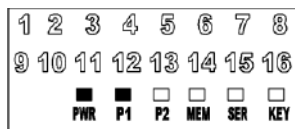

An ENTRY delay countdown timer will be shown at the top right temporarily replace the clock.

6. Once the system is disarmed, the P1 indicator will extinguish and the keypad audible indicator will stop.

Once the system is disarmed, the  icon will extinguish and the keypad audible indicator will stop.

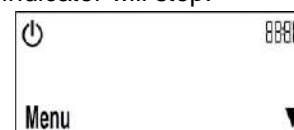
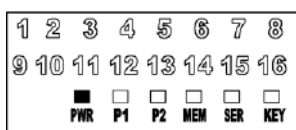

7. If the MEMORY indicator is flashing upon entry there has been an intrusion. Call for assistance. The intruder may still be inside.

If the  icon is flashing upon entry there has been an intrusion. Call for assistance. The intruder may still be inside.

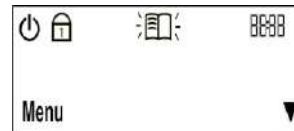
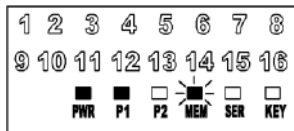

8. If no valid user code has been entered by the end of the **ENTRY** delay period, an **ALARM** condition will be registered and stored into the system **MEMORY**.
9. If programmed to do so, the keypad will be locked and non-responsive for a preprogrammed period for certain number of incorrect user codes, which are entered consecutively more than the keypad lock counter.
10. If the **ENTRY** delay is too short, have your installer to change the **ENTRY** delay period.

REMOTE CONTROL DISARMING

1. To instantly disarm the system, press the remote control button or twist and release the key-switch.
2. The **P1** indicator will extinguish and the keypad audible indicator will sound 2 beeps to confirm the disarming.

The  icon will extinguish and the keypad audible indicator will sound 2 beeps to confirm the disarming.

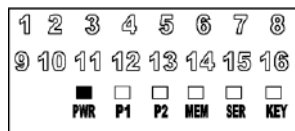

3. If programmed to do so, the siren will sound briefly for this remote control disarming. (Please refer to Installer Programming Section – System Option Setting).

TIMER AUTO DISARMING

1. Your system can be programmed to automatically **DISARM** itself according to a programmed schedule.
2. Please refer to User Programming Section – Program Auto Disarm Timer.

TELEPHONE REMOTE DISARMING

1. Your system can be remotely **DISARM** from outside the house through any normal **DTMF** telephone or **GSM** hand phone.
2. This disarming mode will automatically turn off the security system when the user enters a correct Master Code through Telephone or hand phone.
3. Please refer to Telephony Control Diagram at page 8.

TURN ON/OFF HOME AUTOMATION POINT

[5]

(Press and hold down for 2 seconds)

+ [HA POINT NUMBERS] + [#]

(1 to 16)

1. Enter and hold down **[5]** key for 2 seconds.
2. The **POWER** and **P1** indicators will slow flash and keypad audible indicator will sound 2 beeps.

The screen will show “**HA Info**” and keypad audible indicator will sound 2 beeps.

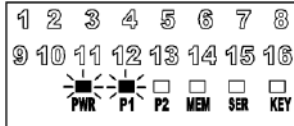

Zone indicators 1 to 16 will turn ON if the respective HA points are ON.

Zone numbers 1 to 16 will be displayed if the respective HA points are ON.

Zone indicators 1 to 16 will turn OFF if the respective HA points are OFF

Zone numbers 1 to 16 will not be displayed if the respective HA points are OFF.

3. Enter the **HA point numbers** followed by **[#]** key. Keypad audible indicator will sound 2 beeps to confirm the command and the system will be back to normal mode.
4. To turn On/Off all Home Automation (**HA**) points at once, enter **[0]** key followed by **[#]**.
5. Keypad audible indicator will sound 2 beeps to confirm the command and the system will be back to normal mode.

e.g. To turn ON/OFF HA point 3 and 4:

Press and hold down **[5]** for 2 seconds + **[3]** + **[4]** + **[#]**

Keypad audible indicator will sound 2 beeps to confirm the command. HA point 3 and 4 will turn ON.

BYPASS ZONE

[6]

(Press and hold down for 2 seconds)

+ [ZONE NUMBERS] + [#]

(1 to 16)

1. Enter and hold down **[6]** key for 2 seconds.
2. The **P1** and **KEYLOCK** indicators will slow flash and keypad audible indicator will sound 2 beeps.

The screen will show “**Bypass Info**” and keypad audible indicator will sound 2 beeps.

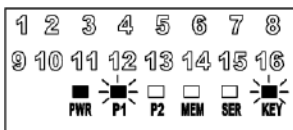

3. Press the zone number that needs to be bypassed, e.g. press **[2]** if you wish to bypass zone 2.

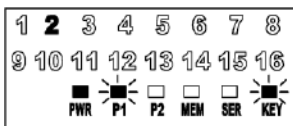

4. To enter zone number more than 9, press button [F] to represent the ten's digit.
5. E.g. To enter zone number 12, press [F] + [2], zone number 16 press [F] + [6].

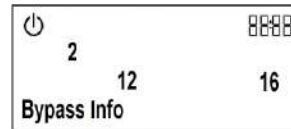
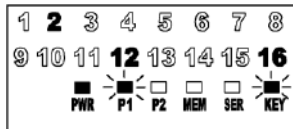

6. Repeat step 3 to bypass other zones.
7. Press [#] key to exit the bypass mode and keypad audible indicator will sound 2 beeps to confirm the command.
8. To bypass all zones at once, enter [0] key followed by [#].
9. Keypad audible indicator will sound 2 beeps to confirm the command and the system will be back to normal mode.
10. The relevant **ZONE** indicator will slow flash to indicate that the zone is bypassed now.

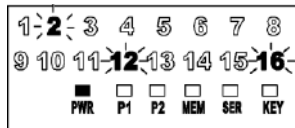

11. Zones cannot be bypassed once the system is armed.
12. All bypassed zones will be automatically un-bypassed each time the system is disarmed and must be reapplied before the next arming.

UN-BYPASS ZONE

[6]
(Press and hold down for 2 seconds)

+ [ZONE NUMBERS] + [#]
(1 to 16)

1. Enter and hold down **[6]** key for 2 seconds.
2. The **P1** and **KEYLOCK** indicators will slow flash and keypad audible indicator will sound 2 beeps.

The screen will show the un-Bypass Zones and keypad audible indicator will sound 2 beeps.

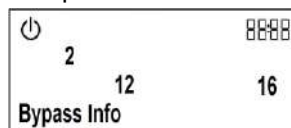
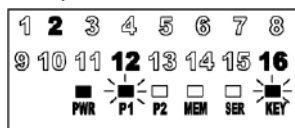

3. Press the zone number corresponding to the current bypassed zone e.g. press **[2]** if you wish to un-bypass zone 2.

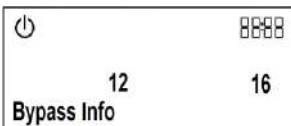
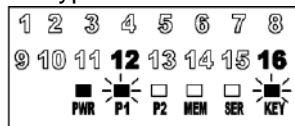

4. To enter zone number more than 9, press button [F] to represent the ten's digit.
5. E.g. To enter zone number 12, press [F] + [2], zone number 16 press [F] + [6].

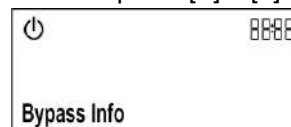
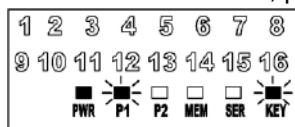

6. Repeat step 3 to un-bypass other zones if any.
7. Press [#] key to exit the un-bypass mode and keypad audible indicator will sound 2 beeps to confirm the command.
8. To un-bypass all zones at once, enter [0] key followed by [#].

9. Keypad audible indicator will sound 2 beeps to confirm the command and the system will be back to normal mode.
10. The relevant **ZONE** indicator will extinguish to indicate that the zone is now active.

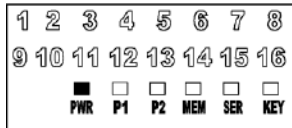

VIEW SYSTEM TROUBLE

[7]

(Press and hold down for 2 seconds)

1. The system will monitor a number of possible trouble conditions. If one of these conditions occurs, the following events will occur.
2. The **SERVICE** indicator turns ON.

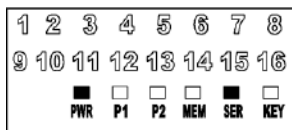

The icon displayed.

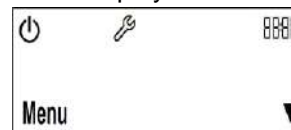

The **SERVICE** indicator will illuminate until the trouble is restored.

The icon will display until the trouble is restored.

3. Enter and hold down [7] key for 2 seconds.

The **SERVICE** and **KEYLOCK** indicators will slow flash and keypad audible indicator will sound 2 beeps.

The screen will show the service indicator and keypad audible indicator will sound 2 beeps.

One or more **ZONE** indicators will turn ON to indicate the troubles occur e.g zone number 2 turning ON indicate Real Time Clock Loss (refer table below).

The trouble occurred will be displayed. Press the [▼] key to check on all the troubles that need to be serviced.

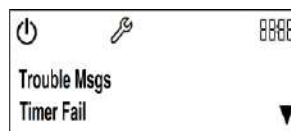
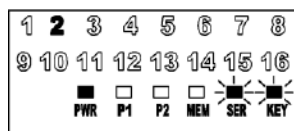

4. Press [#] key to exit and keypad audible indicator will sound 2 beeps.

ZONE 1 indicator	AC Loss
ZONE 2 indicator	Real Time Clock Loss (Program System Timer - refer to page 40)
ZONE 3 indicator	Siren Fail
ZONE 4 indicator	Battery Low Voltage
ZONE 5 indicator	Telephone Line/GSM CMS Reporting Fail
ZONE 6 indicator	Telephone Line/GSM Personal Reporting Fail
ZONE 7 indicator	Telephone Line Connection Fail

Remark: Zone 1, 2, 3 and 4 indicators will only be extinguished after the troubles are restored.
Zone 5, 6 and 7 indicators will be extinguished when they are viewed once.

VIEW ALARM MEMORY

[8]

(Press and hold down for 2 seconds)

1. The system alarm memory will store the most recent alarm condition. An alarm condition will cause the following events.
2. The **MEMORY** indicator slow flash.

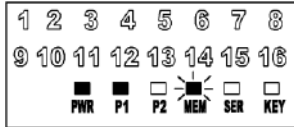

The **MEMORY** indicator will extinguish once the user enters **VIEW ALARM MEMORY** mode.

The  icon flash.



The  icon will extinguish once the user enters **VIEW ALARM MEMORY** mode.

3. Enter and hold down **[8]** key for 2 seconds.

The **MEMORY** indicator will turn ON and keypad audible indicator will sound 2 beeps.

One or more **ZONE** indicators will turn ON to indicate the zones that cause the most recent alarm.

The screen will show **“Alarm Memory”** and keypad audible indicator will sound 2 beeps.

One or more **ZONE** numbers will be displayed to indicate the zones that cause the most recent alarm.

4. Press **[#]** key to exit and keypad audible indicator will sound 2 beeps.

CHIME MODE

The chime mode allows user to monitor nominated zones while the system is disarmed. The audible indicator will sound briefly when the nominated zone is violated – the siren will NOT sound. If you wish to know there is someone enters or exits the front door, the keypad will beep once when the door is opened provided the zone is a chime zone.

[9]

(Press and hold down for 2 seconds)

+ [ZONE NUMBERS] + [#]

(1 to 16)

1. Press and hold down **[9]** key for 2 seconds.
2. The **POWER** and **KEYLOCK** indicators will slow flash and keypad audible indicator will sound 2 beeps.

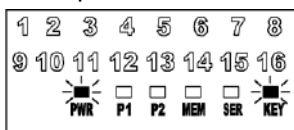

The screen will show **“Chime Info”** and keypad audible indicator will sound 2 beeps.



3. Press the key corresponding to the zone that you wish to be the chime zone.
4. To enter zone number more than 9, press button [F] to represent the ten's digit.
5. E.g. To enter zone number 12, press [F] + [2], zone number 16 press [F] + [6].
6. Press **[#]** key to exit the chime mode and keypad audible indicator will sound 2 beeps to

confirm the command.

e.g. To program zone 3 and zone 4 as CHIME zones:
 Press and hold down **[9]** for 2 seconds + **[3]** + **[4]** + **[#]**
 Keypad audible indicator will sound 2 beeps to confirm the command. Zone 3 and 4 are now CHIME zones.

TO CANCEL CHIME ZONE:

Repeat the above steps and ensure that the zone indicator/display is extinguished.

EMERGENCY SITUATION

FIRE MODE

[F]

(Press and hold down for 2 seconds)

1. This key will activate the FIRE ALARM condition when it is held down for 2 seconds.

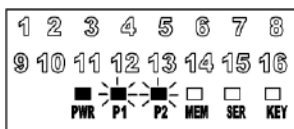

2. The FIRE ALARM condition can also be triggered by an installed smoke detector, which is set as fire zone.
3. The siren will sound and the FIRE REPORTING CODE will be transmitted to the central monitoring station.
4. To silence the siren, enter a 4-digit user code followed by [#] key.

PANIC MODE

1. The PANIC ALARM condition will be activated when:
2. Hold down **[P]** key for 2 seconds Press **[MODE]** followed by **[8]** and **[#]**

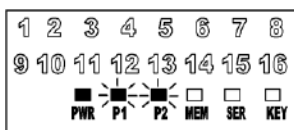

3. The PANIC ALARM condition can also be activated by any FIXED or REMOTE PANIC button that has been installed.
4. If the panic button is set as silent zone, then the PANIC REPORTING CODE will be transmitted to the central monitoring station without the siren sounding. Ensure that your installer has enabled this function if it is required.
5. To silence the siren, enter a valid 4-digit user code followed by [#] key. If the siren is not cancelled, it will stop automatically after the SIREN TIME OUT period.
6. Press this mode only in an emergency situation that requires response by emergency personnel.

MEDICAL MODE

1. The MEDICAL ALARM condition will be activated when:
2. Hold down **[M]** key for 2 seconds Press **[MODE]** followed by **[9]** and **[#]**

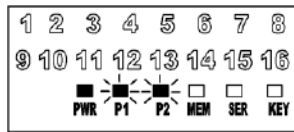

3. The keypad audible indicator will sound to indicate that a MEDICAL ALARM has been initiated.
4. The siren will sound and the MEDICAL REPORTING CODE will be transmitted to the central monitoring station.
5. To silence the siren, enter a 4-digit user code followed by [#] key.

DURESS CODE

1. This is a special 4-digit user code that is only used in the unique situation where an intruder forces one to disarm the system “under duress”.
2. When the duress code is entered, the control panel will be disarmed. However, a DURESS REPORTING CODE is transmitted to the central monitoring station to inform them that you have been forced to disarm the control panel by an intruder.
3. It is advisable to choose a code that can be easily remembered by all family (or staff) members.

PARTITIONING THE SYSTEM

Depending on your needs, your installer can program your control panel to recognize and control 2 separate areas (Partition 1 and Partition 2) by activating the system's partitioning feature. User codes can also be programmed to ARM/DISARM one partition or both partitions simultaneously.

You can use partitioning in installations where shared systems are more practical, such as office/warehouse buildings, or apartment/condominium complexes.

ARMING A PARTITIONED SYSTEM

Zones can be divided into two systems. Based on your requirements, the installer designates which zones belong to Partition 1 and Partition 2, both partitions (dual area), or are not given any partition assignment. A zone belonging to a 2 partitions is armed only when both Partition 1 and Partition 2 are armed. However, this sharing zone will be disarmed if either Partition 1 or Partition 2 is disarmed.

The installer must program the required user code settings. These settings determine which user codes can arm Partition 1, as well as which user codes can arm Partition 2. Codes can also be given access to both partitions.

AWAY ARMING 2 PARTITIONS SIMULTANEOUSLY

If your user code has access to both partitions

[*] + [USER CODE] + [#] + [1] + [2]
(Leave via ENTRY/EXIT Zone)

1. Ensure that all zone indicators are distinguished; if not, check that all protected premises are closed.
2. Press the [*] key to cancel any unintended entries.
3. Enter a valid 4-digit [USER CODE]. If you enter mistakes, press [*] key and re-enter the code followed by [#] key to confirm your command.

4. If the key in user code is assigned to control 2 partitions:

Zone indicators 1 and 2 will flash.

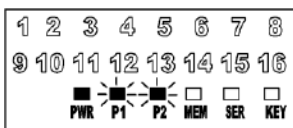

P1 and P2 options will be displayed.

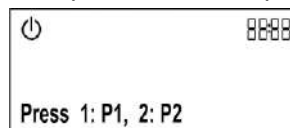

5. Enter key [1] followed by key [2].

The P1 and P2 indicators will illuminate.

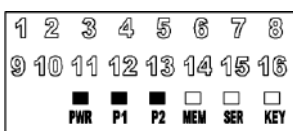

and icons will be displayed.

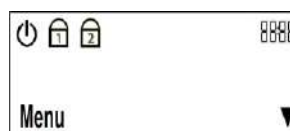

An EXIT delay countdown timer will be

shown at the top right temporarily replace the clock.

6. The keypad audible indicator will sound on and off for the duration of the **EXIT** delay.
7. Any bypassed zones will be shown by the flashing zone indicators.
8. Leave the premises only via the **EXIT/ENTRY** zone.
9. During AWAY arming, the telephone line will be supervised hourly. If the telephone line is disconnected, a new trouble condition will be registered (please refer to View System Trouble).
10. User will be given an **ENTRY** delay time to disarm the system when enter the protected premises via **ENTRY/EXIT** zone.
11. It is also possible to AWAY arm by simply enter and hold down **[1]** key for 2 seconds.

[1] + [1 or 2]
(Press and hold down for 2 seconds)

12. Zone indicator **[1]** and **[2]** will flash. P1 and P2 options will be displayed.

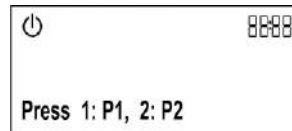
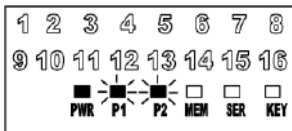

Enter key **[1]** followed by key **[2]** to arm both partitions.

AWAY ARMING EITHER 1 PARTITION

If your user code has access to 2 partitions and you would like to arm Partition 1 only

[*] + [USER CODE] + [#] + [1] + [#]
(Leave via ENTRY/EXIT Zone)

If your user code has access to 2 partitions and you would like to arm Partition 2 only

[*] + [USER CODE] + [#] + [2] + [#]
(Leave via ENTRY/EXIT Zone)

1. Ensure that all zone indicators are distinguished; if not, check that all protected premises are closed.
2. Press the **[*]** key to cancel any unintended entries.
3. Enter a valid 4-digit **[USER CODE]**. If you enter mistakes, press **[*]** key and re-enter the code followed by **[#]** key to confirm your command.
4. Zone indicator **[1]** and **[2]** will flash. P1 and P2 options will be displayed.

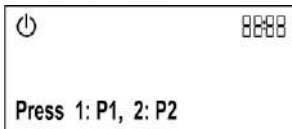
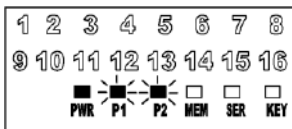

5. Enter the partition number that you wish to arm followed by **[#]** key.
The **P1** indicator will illuminate if Partition 1 is armed.

The  icon will be displayed if Partition 1 is armed.

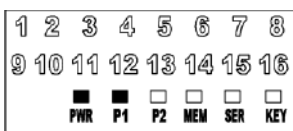

- The **P2** indicator will illuminate if Partition 2 is armed.

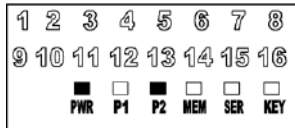

An **EXIT** delay countdown timer will be shown at the top right temporarily replace the clock.

The  icon will be displayed if Partition 2 is armed.

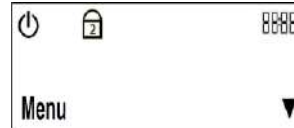

An **EXIT** delay countdown timer will be shown at the top right temporarily replace the clock.

- The keypad audible indicator will sound on and off for the duration of the **EXIT** delay. Any bypassed zones will be shown by the flashing zone indicators.
- Leave the premises only via the **EXIT/ENTRY** zone.
- During AWAY arming, the telephone line will be supervised hourly. If the telephone line is disconnected, a new trouble condition will be registered (please refer to View System Trouble).
- User will be given an **ENTRY** delay time to disarm the system when enter the protected premises via **ENTRY/EXIT** zone.

If your user code has access to 1 partition only

[*] + [USER CODE] + [#]
(Leave via ENTRY/EXIT Zone)

- Ensure that all zone indicators are distinguished; if not, check that all protected premises are closed.
- Press the [*] key to cancel any unintended entries.
- Enter a valid 4-digit [USER CODE]. If you enter mistakes, press [*] key and re-enter the code followed by [#] key to confirm your command.
- The **P1** indicator will illuminate if the entered user code is Partition 1 user code.

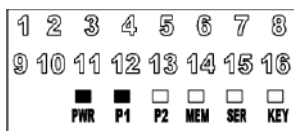

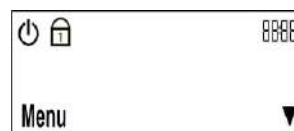

The  icon will be displayed if the entered user code is Partition 1 user code.

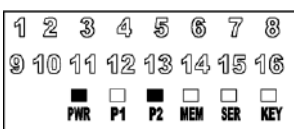

An **EXIT** delay countdown timer will be shown at the top right temporarily replace the clock.

- The **P2** indicator will illuminate if the entered user code is Partition 2 user code.



The  icon will be displayed if the entered user code is Partition 2 user code.

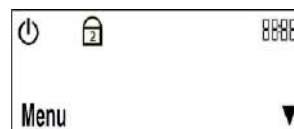

An **EXIT** delay countdown timer will be shown at the top right temporarily replace

the clock.

6. The keypad audible indicator will sound on and off for the duration of the **EXIT** delay. Any bypassed zones will be shown by the flashing zone indicators.
7. Leave the premises only via the **EXIT/ENTRY** zone.
8. During AWAY arming, the telephone line will be supervised hourly. If the telephone line is disconnected, a new trouble condition will be registered (please refer to View System Trouble).
9. User will be given an **ENTRY** delay time to disarm the system when enter the protected premises via **ENTRY/EXIT** zone.

FASTKEY AWAY ARMING EITHER 1 PARTITION

[1] + [1 or 2] + [#]

(Press and hold down for 2 seconds)

1. Ensure that all zone indicators are distinguished; if not, check that all protected premises are closed.
2. Enter and hold down key **[1]** for 2 seconds.
3. Zone indicator **[1]** and **[2]** will flash. P1 and P2 options will be displayed.

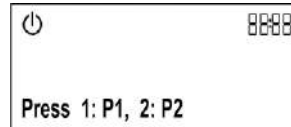
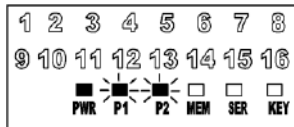

4. Enter key **[1]** to arm Partition 1 or enter key **[2]** to arm Partition 2 followed by **[#]** key.
5. The **P1** indicator will illuminate if Partition 1 is armed.

The  icon will be displayed if Partition 1 is armed.

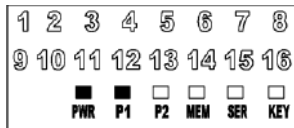

An **EXIT** delay countdown timer will be shown at the top right temporarily replace the clock.

6. The **P2** indicator will illuminate if Partition 2 is armed.

The  icon will be displayed if Partition 2 is armed.

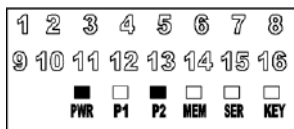

An **EXIT** delay countdown timer will be shown at the top right temporarily replace the clock.

7. The keypad audible indicator will sound on and off for the duration of the **EXIT** delay. Any bypassed zones will be shown by the flashing zone indicators.
8. Leave the premises only via the **EXIT/ENTRY** zone.
9. During AWAY arming, the telephone line will be supervised hourly. If the telephone line is disconnected, a new trouble condition will be registered (please refer to View System Trouble).
10. User will be given an **ENTRY** delay time to disarm the system when enter the protected premises via **ENTRY/EXIT** zone.

PARTITION DAY ARMING

[2] + [1 or 2] + [#]

(Press and hold down for 2 seconds)

1. This arming mode is ideal for **DAY** time arming with user still remains in the protected premises.
2. In this mode, system will be armed instantly with certain preprogrammed, **DAY STAY** zones bypassed automatically.
3. Ensure that all zone indicators are distinguished; if not, check that all protected premises are closed.
4. DO NOT open the **ENTRY/EXIT** zone.
5. Enter and hold down key **[2]** for 2 seconds.
6. Zone indicator **[1]** and **[2]** will flash. P1 and P2 options will be displayed.

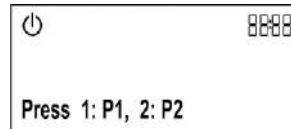
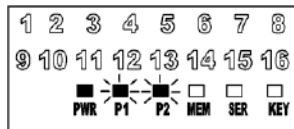

7. Enter key **[1]** to arm Partition 1 or enter key **[2]** to arm Partition 2 followed by **[#]** key.
8. The **P1** indicator will illuminate if Partition 1 is armed.

The  icon will be displayed if Partition 1 is armed.

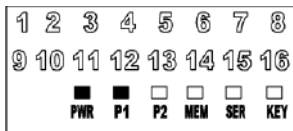

9. The **P2** indicator will illuminate if Partition 2 is armed.

The  icon will be displayed if Partition 2 is armed.

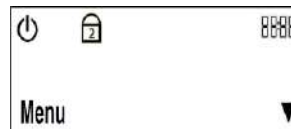
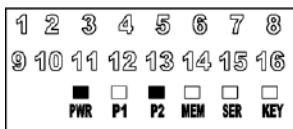

10. Any **DAY STAY** zones will be automatically bypassed (shown by flashing zone indicators).
11. User will be given an **ENTRY** delay time to disarm the system when enter the protected premises via **ENTRY/EXIT** zone.

PARTITION NIGHT ARMING

[3] + [1 or 2] + [#]

(Press and hold down for 2 seconds)

1. This arming mode is ideal for **NIGHT** time arming with user still remains in the protected premises.
2. In this mode, system will be armed instantly with certain preprogrammed, **NIGHT STAY** zones bypassed automatically.
3. Ensure that all zone indicators are distinguished; if not, check that all protected premises are closed.
4. DO NOT open the **ENTRY/EXIT** zone.
5. Enter and hold down key **[3]** for 2 seconds.
6. Zone indicator **[1]** and **[2]** will flash. P1 and P2 options will be displayed.

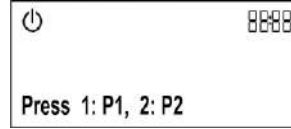
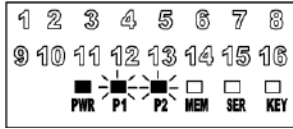

7. Enter key **[1]** to arm Partition 1 or enter key **[2]** to arm Partition 2 followed by **[#]** key.
8. The **P1** indicator will illuminate if Partition 1 is armed.

The  icon will be displayed if Partition 1 is armed.

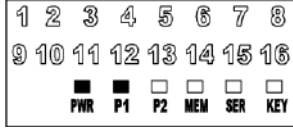

9. The **P2** indicator will illuminate if Partition 2 is armed.

The  icon will be displayed if Partition 2 is armed.

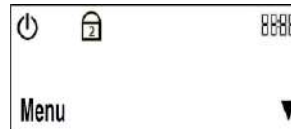
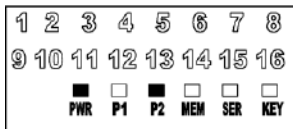

10. Any **NIGHT STAY** zones will be automatically bypassed (shown by flashing zone indicators).
11. There is no **ENTRY** delay in this arming mode. Any violation on the active zones will trigger the system instantly.

PARTITION FORCE ARMING

[4] + [1 or 2] + [#]

(Press and hold down for 2 seconds)

1. In this mode, the system will be armed with EXIT delay time which allows certain violated zones to be bypassed temporary. When the violated zones resume, the zone will be protected again.
2. Enter and hold down key **[4]** for 2 seconds.
3. Zone indicator **[1]** and **[2]** will flash. P1 and P2 options will be displayed.

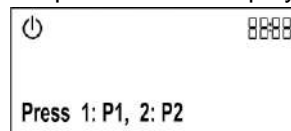
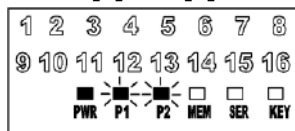

4. Enter key **[1]** to arm Partition 1 or enter key **[2]** to arm Partition 2 followed by **[#]** key.
5. The **P1** indicator will illuminate if Partition 1 is armed.

The  icon will be displayed if Partition 1 is armed.

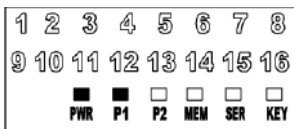

An **EXIT** delay countdown timer will be shown at the top right temporarily replace the clock.

6. The **P2** indicator will illuminate if Partition 2 is armed.

The  icon will be displayed if Partition 2 is armed.

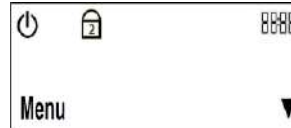
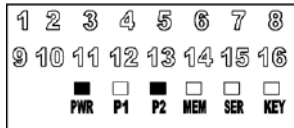

An **EXIT** delay countdown timer will be shown at the top right temporarily replace the clock.

7. Keypad audible indicator will sound on and off for the duration of the **EXIT** delay. Any bypassed zones will be shown by the flashing zone indicators.
8. User will be given an **ENTRY** delay time to disarm the system when enter the protected premises via **ENTRY/EXIT** zone.

PARTITION HOLIDAY ARMING

[0] + [1 or 2] + [#]

(Press and hold down for 2 seconds)

1. This arming mode is ideal for long away occasion (holiday).
2. In this mode, the system will be **AWAY** armed. Home Automation points will be random ON/OFF every hour to simulate occupancy from 7pm to 1am.
3. Ensure that all zone indicators are distinguished; if not, check that all protected premises are closed.
4. Enter and hold down **[0]** key for 2 seconds.
5. Zone indicator **[1]** and **[2]** will flash. P1 and P2 options will be displayed.

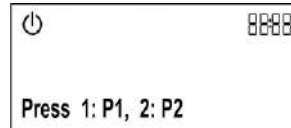
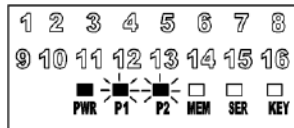

6. Enter key **[1]** to arm Partition 1 or enter key **[2]** to arm Partition 2 followed by **[#]** key.
7. The **P1** indicator will illuminate if Partition 1 is armed.

The icon will be displayed if Partition 1 is armed.

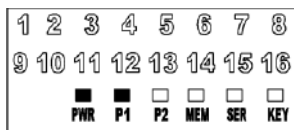

An **EXIT** delay countdown timer will be shown at the top right temporarily replace the clock.

8. The **P2** indicator will illuminate if Partition 2 is armed.

The icon will be displayed if Partition 2 is armed.

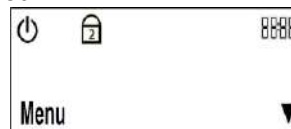
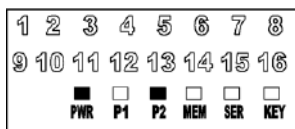

An **EXIT** delay countdown timer will be shown at the top right temporarily replace the clock.

9. Keypad audible indicator will sound on and off for the duration of the **EXIT** delay. Any bypassed zones will be shown by the flashing zone indicators.
10. Leave the premises only via the **EXIT/ENTRY** zone.

11. User will be given an **ENTRY** delay time to disarm the system when enter the protected premises via **ENTRY/EXIT** zone.
12. After disarming, Home Automation random ON/OFF function will be deactivated and the system will resume to normal Home Automation ON/OFF timers setting.

PARTITION DISARMING

[USER CODE] + [#]

1. To disarm the system, enter a valid 4-digit **[USER CODE]** followed by **[#]** key before expiry of the entry delay time.
2. Enter the premises through a designated **ENTRY/EXIT** zone; entering via other zones will trigger an alarm instantly.
3. The **ENTRY** delay begins once the **ENTRY** zone is violated.
4. The keypad audible indicator will sound for the duration of the **ENTRY** delay to indicate that a valid user code is required.
5. Zone indicator **[1]** and **[2]** will flash. P1 and P2 options will be displayed.

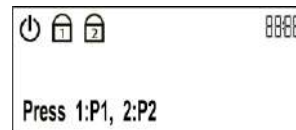
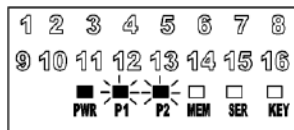

An **ENTRY** delay countdown timer will be shown at the top right temporarily replace the clock.

6. Enter key **[1]** to disarm Partition 1 or enter key **[2]** to disarm Partition 2 followed by **[#]** key.
7. The **P1** indicator will extinguish if Partition 1 is disarmed.

The  icon will extinguish if Partition 1 is disarmed.

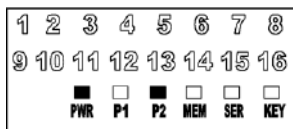

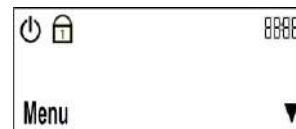
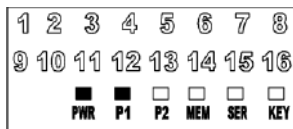

8. The **P2** indicator will extinguish if Partition 2 is disarmed.

The  icon will extinguish if Partition 2 is disarmed.



9. If the **P1** or **P2** indicators remain illuminated, an error has been made while entering the user code, press **[*]** key and re-enter the user code.

If the  or  icons remain illuminated, an error has been made while entering the user code, press **[*]** key and re-enter the user code.

10. Once the system is disarmed, the keypad audible indicator will stop.
11. If no valid user code has been entered by the end of the **ENTRY** delay period, an **ALARM** condition will be registered and stored into the system **MEMORY**.
12. If programmed to do so, the keypad will be locked and non-responsive for a preprogrammed period for certain number of incorrect user codes, which are entered consecutively more than the keypad lock counter (Please refer to Installer Programming Section – Keypad Lock Counter).
13. If the **ENTRY** delay is too short, have your installer to change the **ENTRY** delay period.

- If the **MEMORY** indicator is flashing upon entry, there has been an intrusion. Call for assistance. The intruder may still be inside.

USER CODE

Master code is a 4-digit personal identification number that allows you to enter certain programming mode, arm or disarm the system and remotely control the system via telephone line. In addition to Master Code, V16 Plus can be programmed to accept 13 user codes that allow you to arm/disarm the system. The default Master Code is "1234".

Door Access Code is a special 4-digit code that allows you to control a single door access system. The Door Access Code cannot arm or disarm the security system.

Duress Code is an ambush code which will disarm the system and simultaneously send a silent alarm signal to the center monitoring station. It is very useful code when you are forced to disarm your security system under threat.

USER PROGRAMMING MODE

ENTER USER PROGRAMMING MODE

[*] + [MODE] + [USER MASTER CODE] + [#]

- Ensure that the system is not ARMED.
- Press the **[*]** key to cancel any unintended entries.
- Press **[MODE]** key to go into **USER PROGRAMMING** mode.
- Enter a valid 4-digit **[USER MASTER CODE]**. If you enter any mistakes, press **[*]** key and repeat step 3.
- If a wrong USER MASTER CODE is entered, a long beep will be sound. Repeat step 3-4 to enter USER PROGRAMMING MODE.
- POWER** and **SERVICE** indicators will slow flash and the keypad audible indicator will sound 2 beeps if a valid USER MASTER CODE is entered.

Screen will show "User Mode" and keypad audible indicator will sound 2 beeps if a valid USER MASTER CODE is entered. Below the "User Mode", the "Passwords" command is ready to be entered.

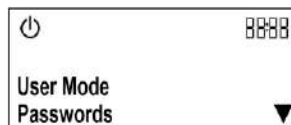
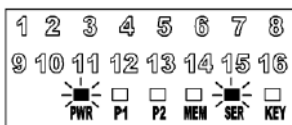

- Enter **COMMAND ADDRESS** according to the setting that you wish to change. (Please refer to User Programming Summary Table (LED) at page 10 & 11)
- Use the **[▲]** key and **[▼]** key to scroll up and down. Enter the command that you wish to change. (Please refer to User Programming Summary Table (LCD) at page 13 to 15)

8. To exit user programming mode, press **[MODE]** followed by **[#]** key. To exit user programming mode press **[*]** or exit from MENU.

EXIT USER PROGRAMMING MODE

1. Press **[MODE]** followed by **[#]** key to exit. Press **[*]** or exit from MENU.
2. **POWER** and **SERVICE** indicators will stop flashing. The keypad will sound 2 beeps to confirm the exit command. Screen will show “Menu” at the bottom (exactly like before entering the user programming mode) and keypad will sound 2 beeps to confirm the exit command.

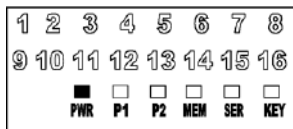

PROGRAM NEW AND CHANGING EXISTING MASTER/USER CODE

1. Ensure that the system is in USER PROGRAMMING mode.

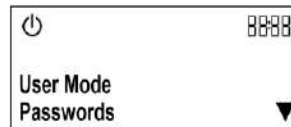
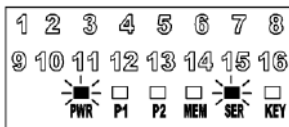

2. Enter **[COMMAND ADDRESS]** that you wish to change **[01-14]**. Press **[#]** to enter Passwords.

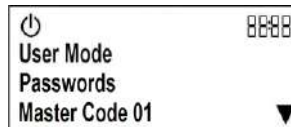

3. Enter the new 4-digit **[USER CODE]** and re-enter the new 4-digit **[USER CODE]** followed by **[#]** key. Press **[#]** to enter Master code 01 for changing the master code.

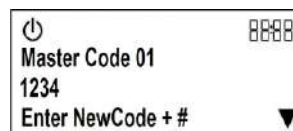

4. Repeat above steps to enter or change other user codes. Enter the new 4-digit **[MASTER CODE]** e.g 4567 followed by **[#]** key.

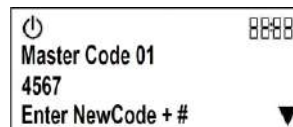

5. To exit user programming mode, press **[MODE]** followed by **[#]** key. Re-enter the new 4-digit **[MASTER CODE]** followed by **[#]** key.

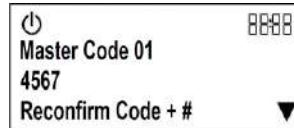

6. - Use the [▲] key and [▼] key to scroll up and down to select other user code and repeat step 3.
7. - Press [*] to exit user programming mode.
8. If any of the user codes are not used, please ensure that they are all erased.

PROGRAM NEW AND CHANGING EXISTING DOOR ACCESS CODE

1. Ensure that the system is in USER PROGRAMMING mode.

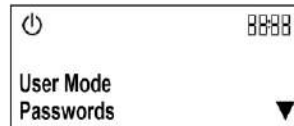
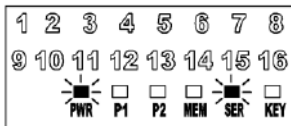

2. Enter command address [15]. Press [#] to enter Passwords.

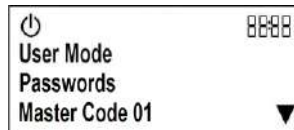

3. Enter the new 4-digit [DOOR ACCESS CODE] and re-enter the new 4-digit [DOOR ACCESS CODE] followed by [#] key. Press [▼] to scroll down to User Code 15.

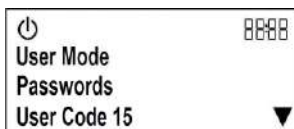

4. To exit user programming mode, press [MODE] followed by [#] key. Press [#] to enter User Code 15.

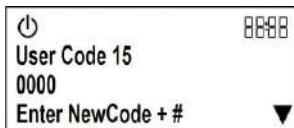

5. - Enter the new 4-digit [DOOR ACCESS CODE] e.g 1212 and press [#].

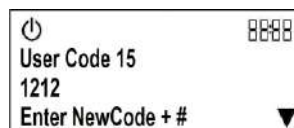

6. - Re-enter the new 4-digit [DOOR ACCESS CODE] e.g 1212 and press [#].

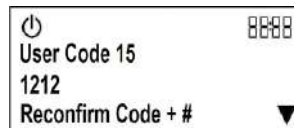

7. - Press **[*]** to exit user programming mode.
8. If any of the user codes are not used, please ensure that they are all erased.

PROGRAM NEW AND CHANGING EXISTING DURESS CODE

1. Ensure that the system is in USER PROGRAMMING mode.

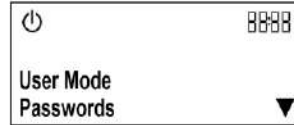
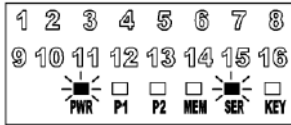

2. Enter command address **[16]**.

Press **[#]** to enter Passwords.

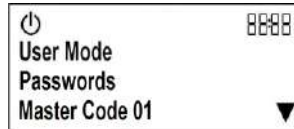

3. Enter the new 4-digit **[DURESS CODE]** and re-enter the new 4-digit **[DURESS CODE]** followed by **[#]** key.

Press **[▼]** to scroll down to Duress Code.

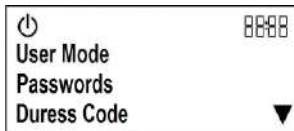

4. To exit user programming mode, press **[MODE]** followed by **[#]** key.

Press **[#]** to enter Duress Code.

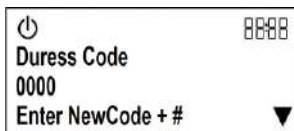

5. -

Enter the new 4-digit **[DURESS CODE]** e.g 1313 and press **[#]**.

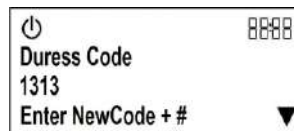

6. -

Re-enter the new 4-digit **[DURESS CODE]** e.g 1313 and press **[#]**.

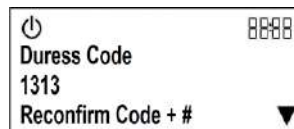

7. -

Press **[*]** to exit user programming mode.

8. If any of the user codes are not used, please ensure that they are all erased.

ERASE USER, DOOR ACCESS or DURESS CODE

1. Ensure that the system is in USER PROGRAMMING mode.

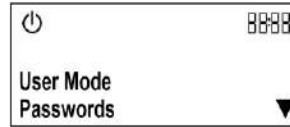
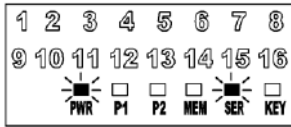

2. Enter **[COMMAND ADDRESS]** that you wish to erase followed by **[#]** key. Press **[#]** to enter Passwords.

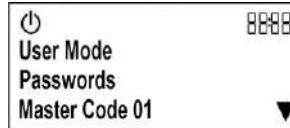

3. Enter the 4-digit **[0000]** and re-enter the 4-digit **[0000]** followed by **[#]** key. Press **[▼]** to scroll down to select which user code that you wish to erase e.g User Code 02.

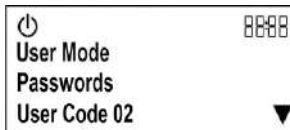

4. Repeat step 2-3 to erase other user codes. Press **[#]** to enter User Code 02.

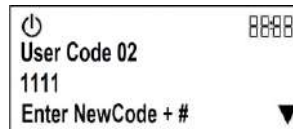

5. To exit user programming mode, press **[MODE]** followed by **[#]** key. Enter the 4-digit **[0000]** followed by **[#]** key.

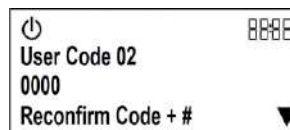

6. - Re-enter the 4-digit **[0000]** followed by **[#]** key.
7. - Repeat step 3 to erase other user codes.
8. - Press **[*]** to exit user programming mode.
9. If any of the user codes are not used, please ensure that they are all erased. (Master code cannot be erased)

PROGRAM SYSTEM TIMER

1. Ensure that the system is in USER PROGRAMMING mode.

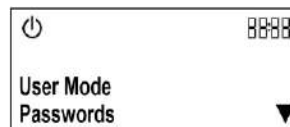

2. Enter **[17]** for system timer setting. Press **[▼]** to scroll down to Clock.

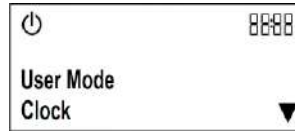

3. Enter the **[CURRENT TIME]** in 24-hour format, e.g. 8:00pm is 20:00. Press **[#]** to enter Clock for system timer setting.

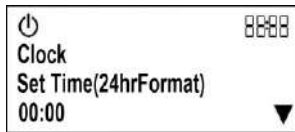

4. Enter **[#]** key to confirm the time. Enter the **[CURRENT TIME]** in 24-hour format e.g. 8:00pm is 20:00.

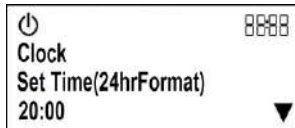

5. To exit user programming mode, press **[MODE]** followed by **[#]** key. Enter **[#]** key to confirm the time.
6. - Press **[*]** to exit user programming mode.

PROGRAM PARTITION 1 AUTO ARM TIMER

1. Ensure that the system is in USER PROGRAMMING mode.

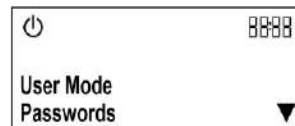
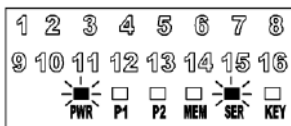

2. Enter **[18]** for auto arm timer setting. Press **[▼]** to scroll down to Timers.

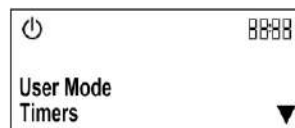

3. Enter the **[AUTO ARM TIMER]** in 24-hour format, e.g. 8:00pm is 20:00. Press **[#]** to enter Timers.

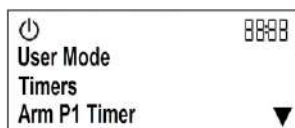

4. Enter **[#]** key to confirm the time. Press **[#]** to enter **Arm P1 Tmr** for auto arm timer setting.

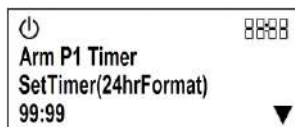

5. To exit user programming mode, press **[MODE]** followed by **[#]** key. Enter the **[AUTO ARM TIMER]** in 24-hour format, e.g. 8:00pm is 20:00.



6. - Enter **[#]** key to confirm the time.
 7. - Press **[*]** to exit user programming mode.

TO ERASE PARTITION 1 AUTO ARM TIMER

1. Ensure that the system is in USER PROGRAMMING mode.

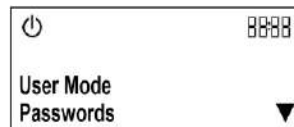
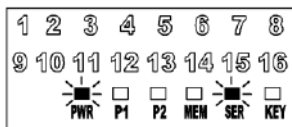

2. Enter **[18]** for auto arm timer setting. Press **[▼]** to scroll down to Timers.

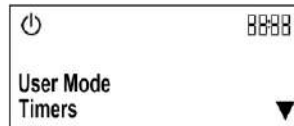

3. Enter the **[#]** key to erase previous AUTO ARM TIMER setting. Press **[#]** to enter Timers.

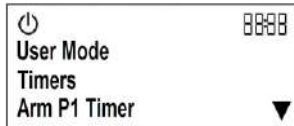

4. To exit user programming mode, press **[MODE]** followed by **[#]** key. Press **[#]** to enter **Arm P1 Tmr** for auto arm timer setting.

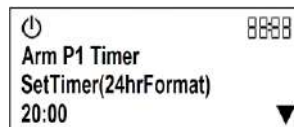

5. - Press the **[F]** key to disable auto disarm timer setting. The setting will be set to 99:99.



6. - Enter the **[#]** key to erase previous AUTO ARM TIMER setting.
 7. - Press **[*]** to exit user programming mode.

PROGRAM PARTITION 1 AUTO DISARM TIMER

1. Ensure that the system is in USER PROGRAMMING mode.

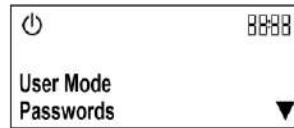
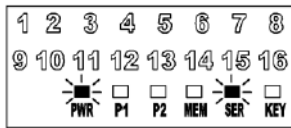

2. Enter [19] for auto disarm timer setting.

Press [▼] to scroll down to Timers.

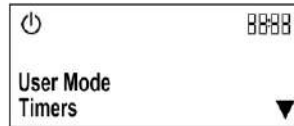

3. Enter the [AUTO DISARM TIMER] in 24-hour format, e.g. 8:00pm is 20:00.

Press [#] to enter Timers.

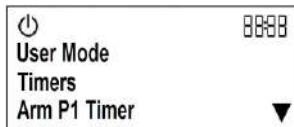

4. Enter [#] key to confirm the time.

Press [▼] to scroll down to **Disarm P1 Tmr.**

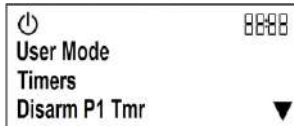

5. To exit user programming mode, press [MODE] followed by [#] key.

Press [#] to enter **Disarm P1 Tmr** for auto disarm timer setting.

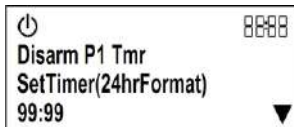

6. -

Enter the [AUTO DISARM TIMER] in 24-hour format, e.g. 8:00pm is 20:00.

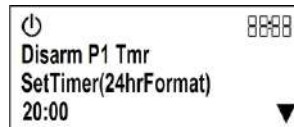

7. -

Enter [#] key to confirm the time.

8. -

Press [*] to exit user programming mode.

TO ERASE PARTITION 1 AUTO DISARM TIMER

1. Ensure that the system is in USER PROGRAMMING mode.

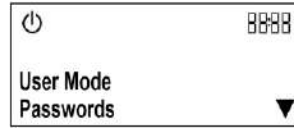
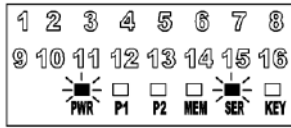

2. Enter **[19]** for auto disarm timer setting.

Press **[▼]** to scroll down to Timers.

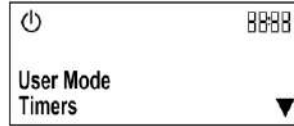

3. Enter the **[#]** key to erase previous AUTO DISARM TIMER setting.

Press **[#]** to enter Timers.

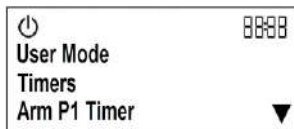

4. To exit user programming mode, press **[MODE]** followed by **[#]** key.

Press **[▼]** to scroll down to **Disarm P1 Tmr.**

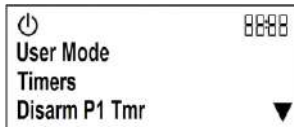

5. -

Press **[#]** to enter **Disarm P1 Tmr** for auto disarm timer setting.

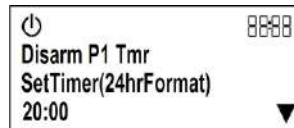

6. -

Press the **[F]** key to disable auto disarm timer setting. The setting will be set to 99:99.

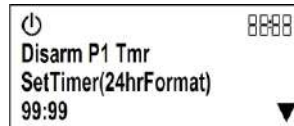

7. -

Enter the **[#]** key to erase previous AUTO DISARM TIMER setting.

8. -

Press **[*]** to exit user programming mode.

PROGRAM PARTITION 2 AUTO ARM TIMER

1. Ensure that the system is in USER PROGRAMMING mode.

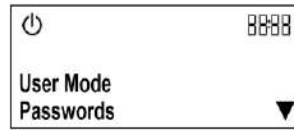
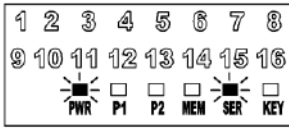

2. Enter **[20]** for auto arm timer setting.

Press **[▼]** to scroll down to Timers.

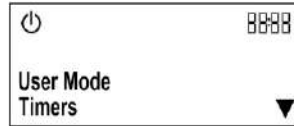

3. Enter the **[AUTO ARM TIMER]** in 24-hour format, e.g. 8:00pm is 20:00.

Press **[#]** to enter Timers.

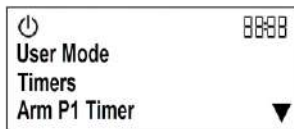

4. Enter **[#]** key to confirm the time.

Press **[▼]** to scroll down to **Arm P2 Timer**.

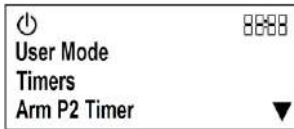

5. To exit user programming mode, press **[MODE]** followed by **[#]** key.

Press **[#]** to enter **Arm P2 Timer** for auto arm timer setting.

6. -

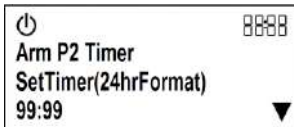

7. -

Enter the **[AUTO ARM TIMER]** in 24-hour format, e.g. 8:00pm is 20:00.

8. -

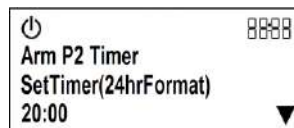

9. -

Enter **[#]** key to confirm the time.

10. -

Press **[*]** to exit user programming mode.

TO ERASE PARTITION 2 AUTO ARM TIMER

1. Ensure that the system is in USER PROGRAMMING mode.

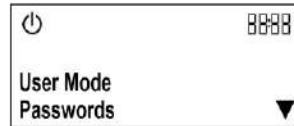
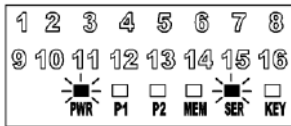

2. Enter **[20]** for auto arm timer setting.

Press **[▼]** to scroll down to Timers.

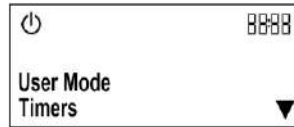

3. Enter the **[#]** key to erase previous AUTO ARM TIMER setting.

Press **[#]** to enter Timers.

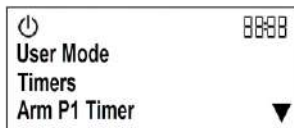

4. To exit user programming mode, press **[MODE]** followed by **[#]** key.

Press **[▼]** to scroll down to **Arm P2 Timer**.

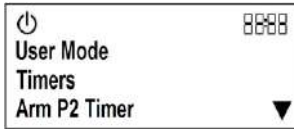

5. -

Press **[#]** to enter **Arm P2 Timer** for auto arm timer setting.

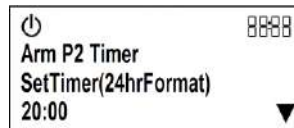

6. -

Press the **[F]** key to disable auto arm timer setting. The setting will be set to 99:99.

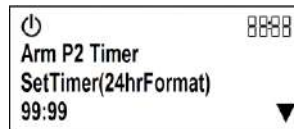

7. -

Enter the **[#]** key to erase previous AUTO ARM TIMER setting.

8. -

Press **[*]** to exit user programming mode.

PROGRAM PARTITION 2 AUTO DISARM TIMER

1. Ensure that the system is in USER PROGRAMMING mode.

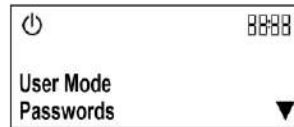
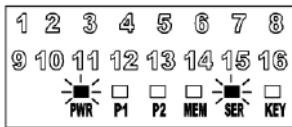

2. Enter **[21]** for auto disarm timer setting.

Press **[▼]** to scroll down to Timers.

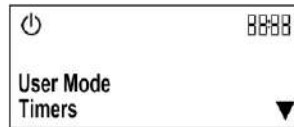

3. Enter the **[AUTO DISARM TIMER]** in 24-hour format, e.g. 8:00pm is 20:00.

Press **[#]** to enter Timers.

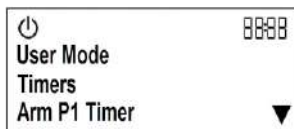

4. Enter **[#]** key to confirm the time.

Press **[▼]** to scroll down to **Disarm P2 Tmr.**

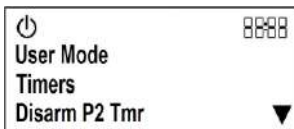

5. To exit user programming mode, press **[MODE]** followed by **[#]** key.

Press **[#]** to enter **Disarm P2 Tmr** for auto disarm timer setting.

6. -

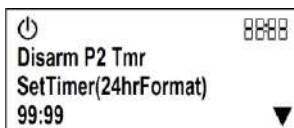

7. -

Enter the **[AUTO DISARM TIMER]** in 24-hour format, e.g. 8:00pm is 20:00.

8.

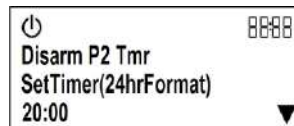

9. -

Enter **[#]** key to confirm the time.

10. -

Press **[*]** to exit user programming mode.

TO ERASE PARTITION 2 AUTO DISARM TIMER

1. Ensure that the system is in USER PROGRAMMING mode.

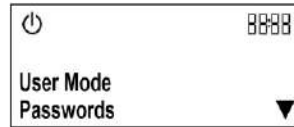
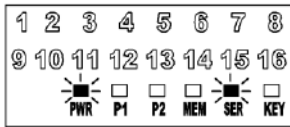

2. Enter **[21]** for auto disarm timer setting.

Press **[▼]** to scroll down to Timers.

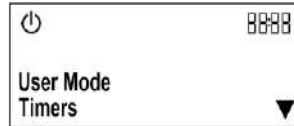

3. Enter the **[#]** key to erase previous AUTO DISARM TIMER setting.

Press **[#]** to enter Timers.

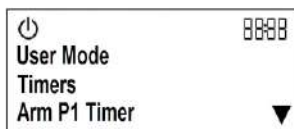

4. To exit user programming mode, press **[MODE]** followed by **[#]** key.

Press **[▼]** to scroll down to **Disarm P2 Tmr.**

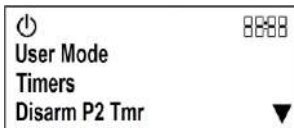

5. -

Press **[#]** to enter **Disarm P2 Tmr** for auto disarm timer setting.

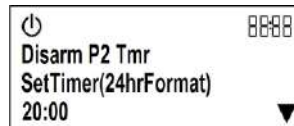

6. -

Press the **[F]** key to disable auto disarm timer setting. The setting will be set to 99:99.

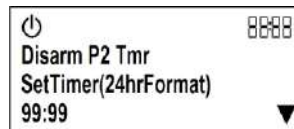

7. -

Enter the **[#]** key to erase previous AUTO DISARM TIMER setting.

8. -

Press **[*]** to exit user programming mode.

PROGRAM AUTO ON TIMER 1/2/3/4 FOR HOME AUTOMATION

1. Ensure that the system is in USER PROGRAMMING mode.

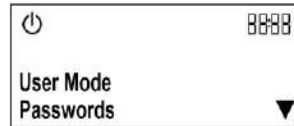
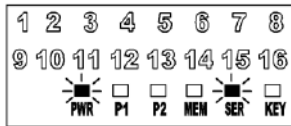

2. Enter **[22]** for auto on timer 1 setting.*

Press **[▼]** to scroll down to Timers.

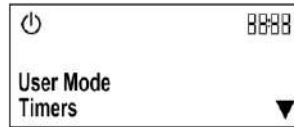

3. Enter the **[AUTO ON TIMER 1]** in 24-hour format, e.g. 8:00pm is 20:00.

Press **[#]** to enter Timers.

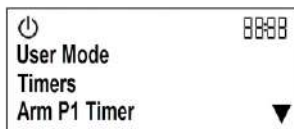

4. Enter **[#]** key to confirm the time.

Press **[▼]** to scroll down to **ON HA Tmr 1.** **

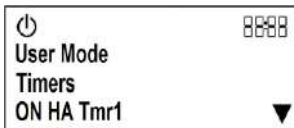

5. To exit user programming mode, press **[MODE]** followed by **[#]** key.

Press **[#]** to enter **ON HA Tmr 1** for auto on timer 1 setting.

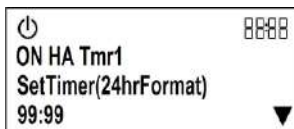

6. -

Enter the **[AUTO ON TIMER 1]** in 24-hour format, e.g. 8:00pm is 20:00.

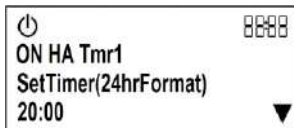

7. -

Enter **[#]** key to confirm the time.

8. -

Press **[*]** to exit user programming mode.

* Enter **[24]** for auto on timer 2 setting OR
 Enter **[26]** for auto on timer 3 setting OR
 Enter **[28]** for auto on timer 4 setting.

** Press **[▼]** to scroll down to **ON HA Tmr 2** and press **[#]** to enter for auto on timer 2 setting OR
 Press **[▼]** to scroll down to **ON HA Tmr 3** and press **[#]** to enter for auto on timer 3 setting OR
 Press **[▼]** to scroll down to **ON HA Tmr 4** and press **[#]** to enter for auto on timer 4 setting.

TO ERASE AUTO ON TIMER 1/2/3/4 FOR HOME AUTOMATION

1. Ensure that the system is in USER PROGRAMMING mode.

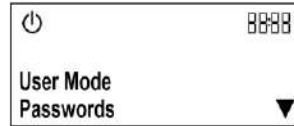
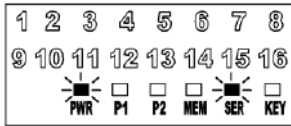

2. Enter **[22]** for auto on timer 1 setting.*

Press **[▼]** to scroll down to Timers.

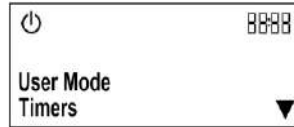

3. Enter the **[#]** key to erase previous AUTO ON TIMER 1 setting.

Press **[#]** to enter Timers.

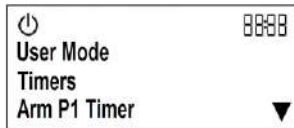

4. To exit user programming mode, press **[MODE]** followed by **[#]** key.

Press **[▼]** to scroll down to **ON HA Tmr 1.** **

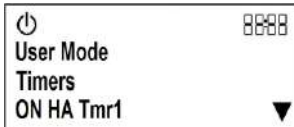

5. -

Press **[#]** to enter **ON HA Tmr 1** for auto on timer 1 setting.

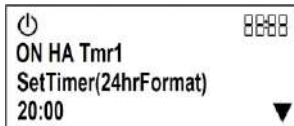

6. -

Press the **[F]** key to disable AUTO ON TIMER 1 setting. The setting will be set to 99:99.

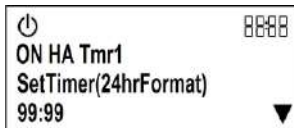

7. -

Enter the **[#]** key to erase previous AUTO ON TIMER 1 setting.

8. -

Press **[*]** to exit user programming mode.

* Enter **[24]** for auto on timer 2 setting OR
Enter **[26]** for auto on timer 3 setting OR
Enter **[28]** for auto on timer 4 setting.

** Press **[▼]** to scroll down to **ON HA Tmr 2** and press **[#]** to enter for auto on timer 2 setting OR
Press **[▼]** to scroll down to **ON HA Tmr 3** and press **[#]** to enter for auto on timer 3 setting OR
Press **[▼]** to scroll down to **ON HA Tmr 4** and press **[#]** to enter for auto on timer 4 setting.

PROGRAM AUTO OFF TIMER 1/2/3/4 FOR HOME AUTOMATION

1. Ensure that the system is in USER PROGRAMMING mode.

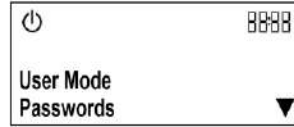
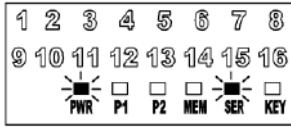

2. Enter **[23]** for auto off timer 1 setting.*

Press **[▼]** to scroll down to Timers.

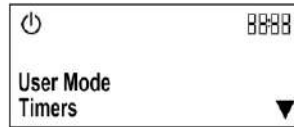

3. Enter the **[AUTO OFF TIMER 1]** in 24-hour format, e.g. 8:00pm is 20:00.

Press **[#]** to enter Timers.

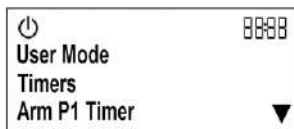

4. Enter **[#]** key to confirm the time.

Press **[▼]** to scroll down to **OFF HA Tmr 1.****

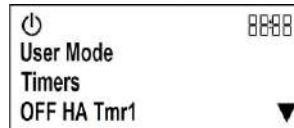

5. To exit user programming mode, press **[MODE]** followed by **[#]** key.

Press **[#]** to enter **OFF HA Tmr 1** for auto off timer 1 setting.

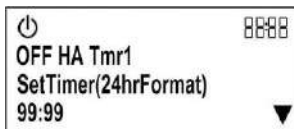

6. -

Enter the **[AUTO OFF TIMER 1]** in 24-hour format, e.g. 8:00pm is 20:00.

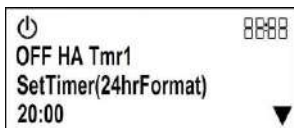

7. -

Enter **[#]** key to confirm the time.

8. -

Press **[*]** to exit user programming mode.

* Enter **[25]** for auto off timer 2 setting OR
 Enter **[27]** for auto off timer 3 setting OR
 Enter **[29]** for auto off timer 4 setting.

** Press **[▼]** to scroll down to **OFF HA Tmr 2** and press **[#]** to enter for auto off timer 2 setting OR
 Press **[▼]** to scroll down to **OFF HA Tmr 3** and press **[#]** to enter for auto off timer 3 setting OR
 Press **[▼]** to scroll down to **OFF HA Tmr 4** and press **[#]** to enter for auto off timer 4 setting.

TO ERASE AUTO OFF TIMER 1/2/3/4 FOR HOME AUTOMATION

1. Ensure that the system is in USER PROGRAMMING mode.



2. Enter **[23]** for auto off timer 1 setting.*

Press **[▼]** to scroll down to Timers.



3. Enter the **[#]** key to erase previous AUTO OFF TIMER 1 setting.

Press **[#]** to enter Timers.



4. To exit user programming mode, press **[MODE]** followed by **[#]** key.

Press **[▼]** to scroll down to **OFF HA Tmr 1. ****

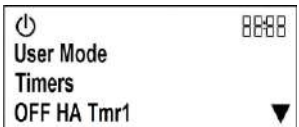

5. -

Press **[#]** to enter **OFF HA Tmr 1** for auto off timer 1 setting.



6. -

Press the **[F]** key to disable AUTO OFF TIMER 1 setting. The setting will be set to 99:99.

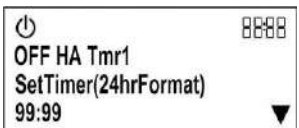

7. -

Enter the **[#]** key to erase previous AUTO OFF TIMER 1 setting.

8. -

Press **[*]** to exit user programming mode.

* Enter **[25]** for auto off timer 2 setting OR
 Enter **[27]** for auto off timer 3 setting OR
 Enter **[29]** for auto off timer 4 setting.

** Press **[▼]** to scroll down to **OFF HA Tmr 2** and press **[#]** to enter for auto off timer 2 setting OR
 Press **[▼]** to scroll down to **OFF HA Tmr 3** and press **[#]** to enter for auto off timer 3 setting OR
 Press **[▼]** to scroll down to **OFF HA Tmr 4** and press **[#]** to enter for auto off timer 4 setting.

PROGRAM PERSONAL TELEPHONE NUMBER 1/2/3/4

1. Ensure that the system is in USER PROGRAMMING mode.

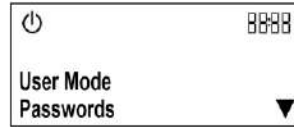
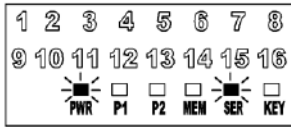

2. Enter **[30]** for personal telephone number 1 setting.* Press **[▼]** to scroll down to **TelNos**.

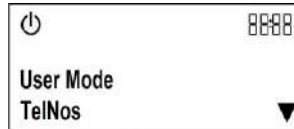

3. Enter the **[PERSONAL TELEPHONE NUMBER 1]**, the maximum telephone number length is 14 digits. Press **[#]** to enter **TelNos**.

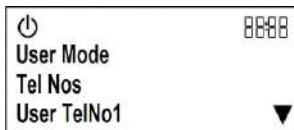

4. Button **"P"** on the keypad is representing a "PAUSE" key of 5 seconds duration. Press **[#]** to enter **User TelNo1.****

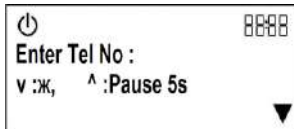

5. Button **"M"** on the keypad is representing a "※" key. Enter the **[PERSONAL TELEPHONE NUMBER 1]**, the maximum telephone number length is 14 digits. The entered number will be displayed on the screen.

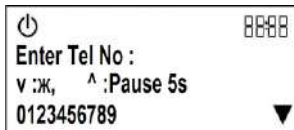

6. Enter **[#]** key to confirm the setting. Press the **[F]** key to temporary erase setting or wrong keyed in numbers.

7. To exit user programming mode, press **[MODE]** followed by **[#]** key. Button **"▲"** on the keypad is representing a "PAUSE" key of 5 seconds duration.

8. - Button **"▼"** on the keypad is representing a "※" key.

9. - Enter **[#]** key to confirm the setting.

10. - Press **[*]** to exit user programming mode.

11. If programmed so, system will call out to user telephone to report any intrusion.

12. If the system fails to contact the preprogrammed personal telephone number 1, system will contact **PERSONAL TELEPHONE NUMBER 2 to 4** as a backup. If the system fails to report to all telephone numbers, a new trouble condition will be registered (please refer to View System Trouble).

* Enter **[31]** for personal telephone number **2** setting OR
 Enter **[32]** for personal telephone number **3** setting OR
 Enter **[33]** for personal telephone number **4** setting.

** Press **[▼]** to scroll down to **User TelNo2** and press **[#]** to enter for personal telephone number **2** setting OR
 Press **[▼]** to scroll down to **User TelNo3** and press **[#]** to enter for personal telephone number **3** setting OR
 Press **[▼]** to scroll down to **User TelNo4** and press **[#]** to enter for personal telephone number **4** setting.

TO ERASE PERSONAL TELEPHONE NUMBER 1/2/3/4

1. Ensure that the system is in USER PROGRAMMING mode.

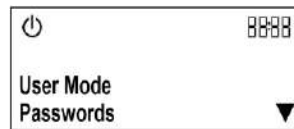
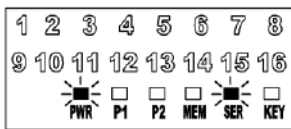

2. Enter **[30]** for personal telephone number 1 setting.* Press **[▼]** to scroll down to **TelNos**.

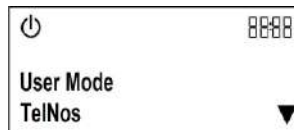

3. Enter the **[#]** key to erase previous personal telephone number 1 setting. Press **[#]** to enter **TelNos**.

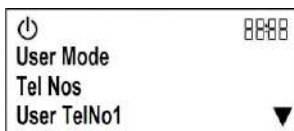

4. To exit user programming mode, press **[MODE]** followed by **[#]** key. Press **[#]** to enter **User TelNo1****

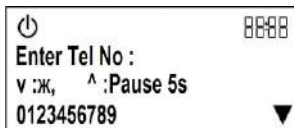

5. - Press the **[F]** key to erase and the setting will be emptied.

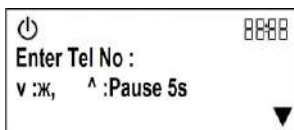

6. - Enter the **[#]** key to erase previous personal telephone number 1 setting.

7. - Press **[*]** to exit user programming mode.

- * Enter [31] for personal telephone number 2 setting OR
Enter [32] for personal telephone number 3 setting OR
Enter [33] for personal telephone number 4 setting.
- ** Press [▼] to scroll down to **User TelNo2** and press [#] to enter for personal telephone number 2 setting OR
Press [▼] to scroll down to **User TelNo3** and press [#] to enter for personal telephone number 3 setting OR
Press [▼] to scroll down to **User TelNo4** and press [#] to enter for personal telephone number 4 setting.

PROGRAM SYSTEM DATE (FOR LCD ONLY)

1. Ensure that the system is in USER PROGRAMMING mode.



2. Press [▼] to scroll down to Date.

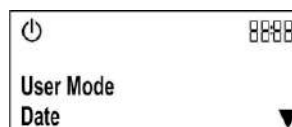

3. Press [#] to enter Date.

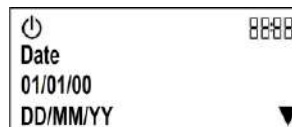

4. Enter the [DATE] in DDMMYY format, e.g 22nd February 2010 is 220210.

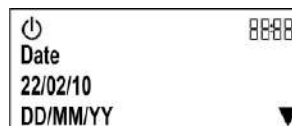

5. Enter the [#] key to confirm the date.
6. Press [*] to exit user programming mode.

PROGRAM SECURITY AND HOME AUTOMATION TIMER SCHEDULE (FOR LCD ONLY)

1. Ensure that the system is in USER PROGRAMMING mode.

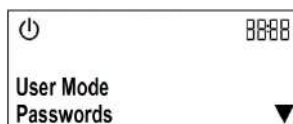

2. Press [▼] to scroll down to **Schedule**.

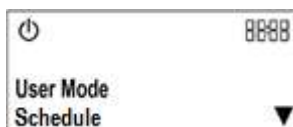

3. Press [#] to access **Schedule** menu.

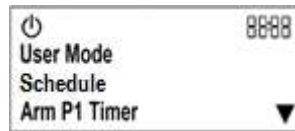

4. Press [#] to access **Arm P1 Timer Schedule** for auto arm partition 1 timer schedule.

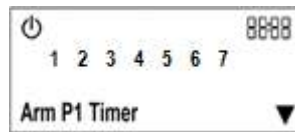

5. The default setting is number 1 to 7 ON (1 for Monday, 2 for Tuesday, 3 for Wednesday, 4 for Thursday, 5 for Friday, 6 for Saturday and 7 for Sunday). It means that **Arm P1 Timer** will be activated from Monday to Sunday.

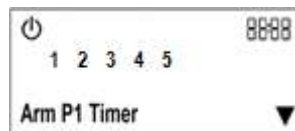

6. If you want to activate the **Arm P1 Timer** from Monday to Friday (weekdays) only, press 6 and 7 to turn OFF number 6 (Saturday) and 7 (Sunday).
7. Press [#] key to confirm the schedule.
8. Press [▼] to scroll down to program **Disarm P1 Timer Schedule, Arm P2 Timer Schedule, Disarm P2 Timer Schedule, ON HA Timer 1/2/3/4 Schedule and OFF HA Timer 1/2/3/4 Schedule.**
9. Press [*] to exit user programming mode.

TESTING THE SYSTEM

Users are advised to test the system as frequent as possible. System must be tested at least once every 3 months. If the system is not functioning accordingly, please contact your system installer for technical assistance.

WALK TEST

1. Walk Test allows on-site testing of each zone of the system.
2. Press **[MODE] + [1] + [#]**. Press **[MODE] + [1] + [#]** or enter from MENU.
(Menu ⇒ System Test ⇒ Walk Test)

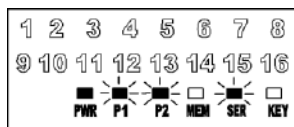

3. Siren will trigger for 2 seconds and keypad buzzer will sound briefly if any zone is violated during walk test mode.
4. If siren and keypad do not sound when zone is violated, consult your system installer.
5. To exit Walk Test, simply press [#] key.

CMS TEST (Manual Test)

1. CMS Test allows on-site testing of CMS Reporting.
2. Press **[MODE] + [2] + [#]**.

Press **[MODE] + [2] + [#]** or enter from MENU.

(Menu ⇒ System Test ⇒ CMS Test)

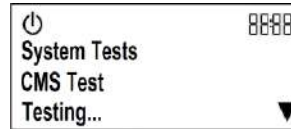
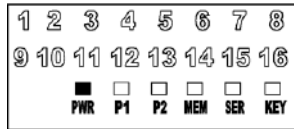

3. A CMS testing code will be sent to the central monitoring station.
4. Wait for 2 minutes, if CMS reporting fails then a new trouble condition will be registered.
5. Press and hold down **[7]** key for 2 seconds to view trouble condition and consult your system installer.
6. Please refer to **View System Trouble**.

SIREN TEST

1. Siren Test allows on-site testing of siren functionality.
2. Press **[MODE] + [3] + [#]**.

Press **[MODE] + [3] + [#]** or enter from MENU.

(Menu ⇒ System Test ⇒ Siren Test)

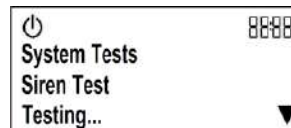
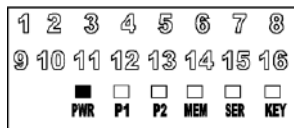

3. Siren will sound for 3 seconds.
4. If siren does not sound, consult your system installer.

STROBE LIGHT TEST

1. Strobe Light Test allows on-site testing of strobe light functionality.
2. Press **[MODE] + [4] + [#]**.

Press **[MODE] + [4] + [#]** or enter from MENU.

(Menu ⇒ System Test ⇒ Strobe Test)

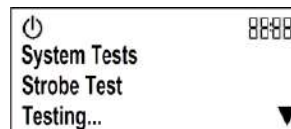
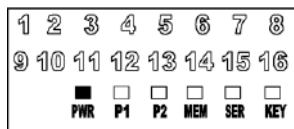

3. Strobe light will flash for 15 seconds.
4. If strobe light does not flash, consult your system installer.

BATTERY TEST

- Battery Test allows on-site testing of battery functionality.
- Press **[MODE] + [5] + [#]**. Press **[MODE] + [5] + [#]** or enter from MENU.
(Menu ⇒ System Test ⇒ Battery Test)

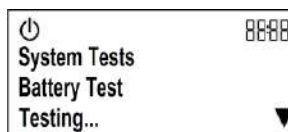
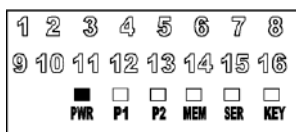

- Wait for 5 seconds, if back-up battery fails then a new trouble condition will be registered.
- Press and hold down **[7]** key for 2 seconds to view the trouble condition and consult your system installer.

SYSTEM INFORMATION

SECURITY ZONE INFORMATION

Zone No.	Partition 1 or 2 or both	Zone Type e.g. Entry/Exit Delay	Location e.g. Main door
1			
2			
3			
4			
5			
6			
7			
8			
9			
10			
11			
12			
13			
14			
15			
16			

SYSTEM SETTING INFORMATION**Partition 1**

Entry Time Partition 1 : _____ seconds
Exit Time Partition 1 : _____ seconds
Siren Cut-Off Time for Partition 1 : _____ minutes

Partition 2

Entry Time Partition 2 : _____ seconds
Exit Time Partition 2 : _____ seconds
Siren Cut-Off Time for Partition 2 : _____ minutes

Telephone Reporting

Telephone Number 1 : _____
Telephone Number 2 : _____
Telephone Number 3 : _____
Telephone Number 4 : _____
Dialing Attempt : _____ times

Home Automation

Home Automation 1 Turn On Time ____ : ____ am / pm
Home Automation 1 Turn Off Time ____ : ____ am / pm
Home Automation 2 Turn On Time ____ : ____ am / pm
Home Automation 2 Turn Off Time ____ : ____ am / pm
Home Automation 3 Turn On Time ____ : ____ am / pm
Home Automation 3 Turn Off Time ____ : ____ am / pm
Home Automation 4 Turn On Time ____ : ____ am / pm
Home Automation 4 Turn Off Time ____ : ____ am / pm

CMS

Central Monitoring Station Number : _____
Central Monitoring Station Account Number : _____

Servicing

Installer company : _____
Contact person : _____
Contact number : _____
Installation Date : ____ / ____ / ____