

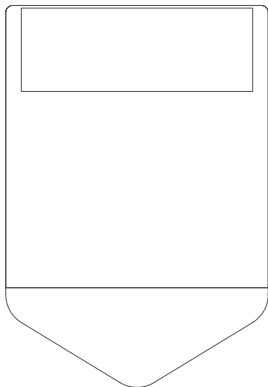

— Outdoor Siren —



Quick Start Guide

Appearance

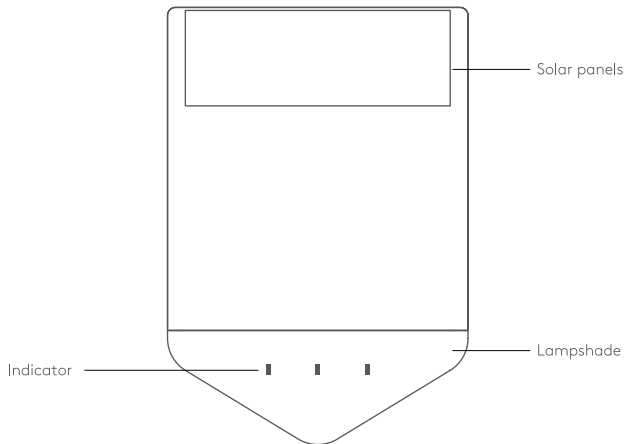

Appearance

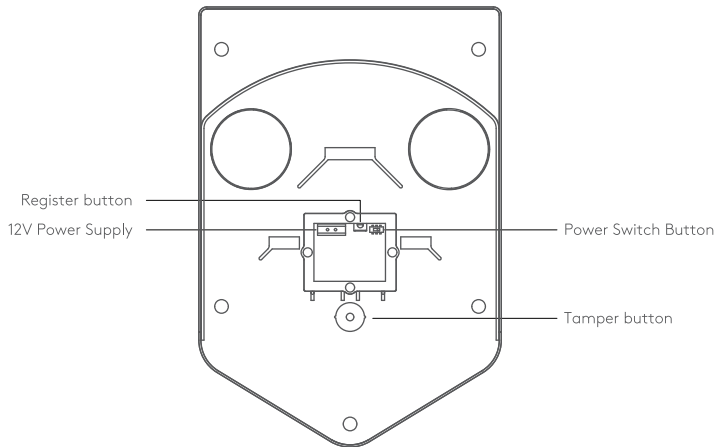

Packaging List

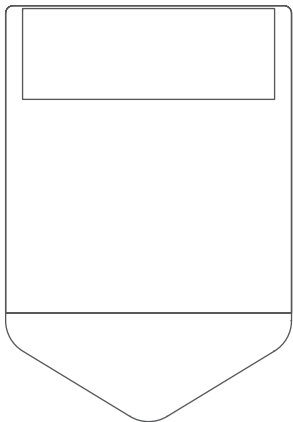

Outdoor siren x1

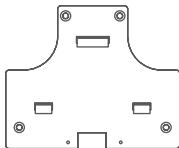

Mounting bracket x1



Mounting screw x3

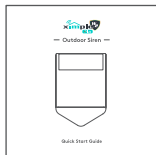

QSG x1

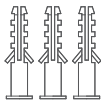

Plastic expansion tube x3

Download App :

- 1 Open your smartphone camera.
- 2 Scan the QR code below.
- 3 Tap the link that appears.
- 4 Download and install the Ximple W2 Plus app.



Ximple W2 Plus



Add Outdoor Siren

Please make sure you have logged into the App and completed adding the home security hub before adding peripheral.

- ① Click Home Security Hub to enter peripheral page, then click "+" on the top right corner and select "Add peripheral" to enable enrollment mode.

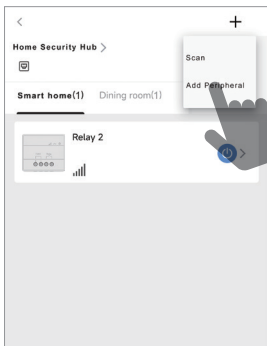

- ② Power up the outdoor siren by turning on the power switch , the indicator will start flashing continuously and the device will automatically show up in the App interface.

Note: If the device does not show up in the APP interface until green indicator is off, please press and hold the device register button for 5s to try again.

Add Outdoor Siren

- ③ Assign room for the outdoor siren and click the "Done" button , the outdoor siren is added successfully.

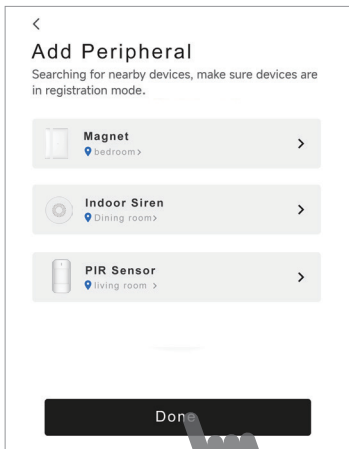
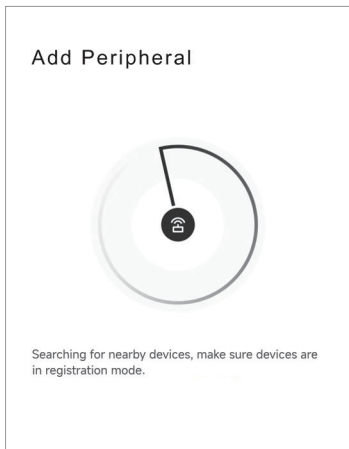

Testing Instruction

Signal Strength Test

This step checks that the signal strength of the communication between the device at its current location and the Home Security Hub.

- ① Click the "⚙️" button in the top right corner of the outdoor siren details page.
- ② Click on "Signal Strength Test".
- ③ Click the "▶️" button to check the result of signal strength test.

It is not advisable to install here.



It is suitable to install here.



It is suitable to install here.



Installation Instruction

Mount on the wall by screws

- ① Drill four holes in the wall, and then insert the expansion bolts into the holes.
- ② Fasten the back panel to the wall with four screws.

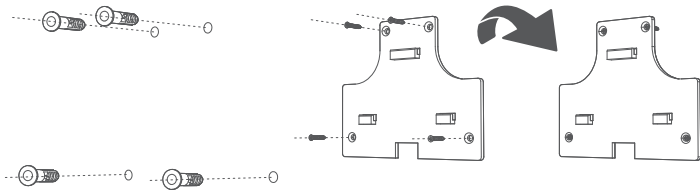

- ③ Secure outdoor siren to the back panel with three hooks.

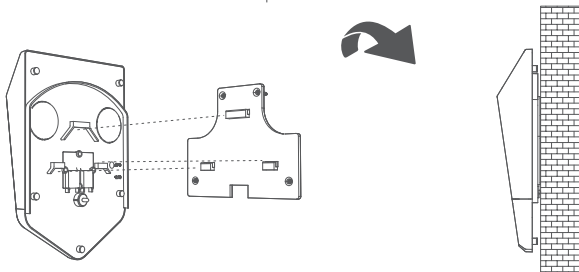

Testing Instruction

Volume Test

This step checks whether the outdoor siren volume meets your needs. The outdoor siren volume is divided into three levels: high (105dB), medium (95dB), and low (85dB). You can adjust the volume via App.

- ① Click the "⚙️" button in the top right corner of the outdoor siren details page.
- ② Click on "Volume Test".
- ③ Click the "▶️" button to check the result of volume test.
- ④ Click on "Alarm Settings" to adjust the outdoor siren volume.

Device specifications

Feature	
Alarm Buzzer	85dB/95dB/105dB
Advanced Features	Signal Strength detection,Find me
Tamper Protection	Rear
LED Indicator	3
Wireless Transmission	
Transmission Frequency	921MHz
Transmission Range(Open Space)	1000m
Advanced Tech	AES-128 Encryption,FHSS,TDMA
Electrical Characteristics	
Power Supply	1700mAh Lithium battery with Solar charging, Battery Life Up to 2 years (standby mode)
General	
Operation Temperature	-10°C to 55°C (14 °F to 131 °F)
Dimension(WxHxD)	290mm*200mm*58mm
Weight	655.5g
IP Rate	IP65
Installation Method	Wall mounting
Application Scenario	Outdoor

Powered by ***bluguard***[®]

 www.bluguard.com.my