

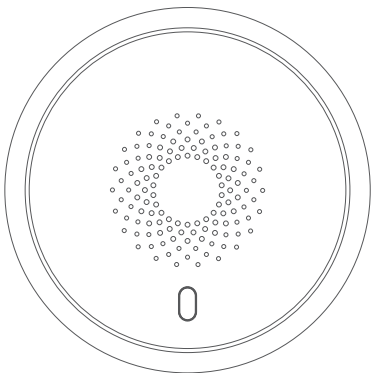

— Smoke Detector —



Quick Start Guide

Appearance

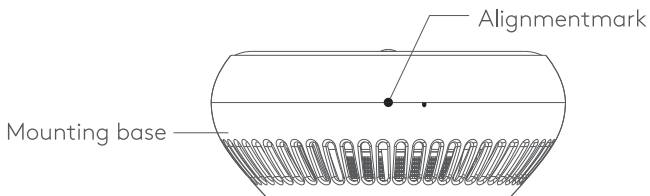
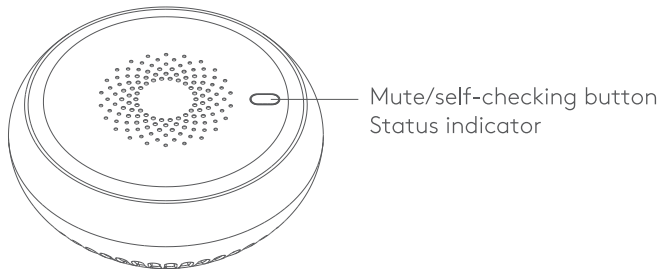

Packaging List

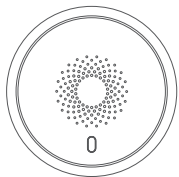

Smoke Detector x1

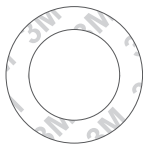

3M adhesive strip x1

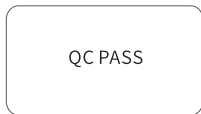

QC PASS certificate x1

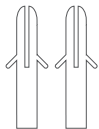

Plastic expansion
tube x2



Mounting screw x2

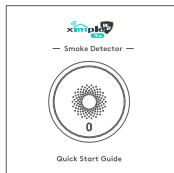

QSG x1

Download App :

- 1 Open your smartphone camera.
- 2 Scan the QR code below.
- 3 Tap the link that appears.
- 4 Download and install the Ximple W2 Plus app.



Ximple W2 Plus



Add Smoke Detector

- 1 Click Home Security Hub , then click "+" and select "Add peripheral" .

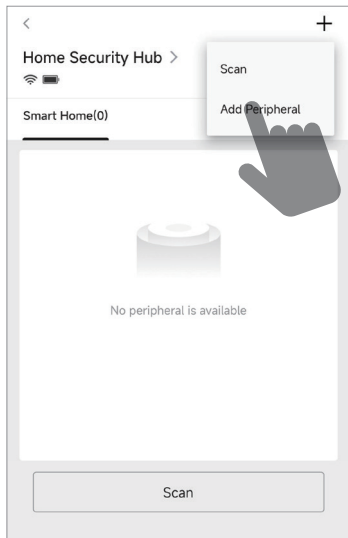

Add Smoke Detector

2 Power up the device.

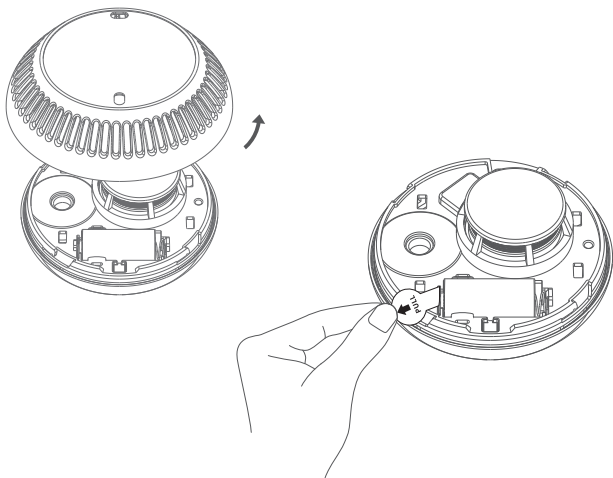

Add Smoke Detector

- 3 Press the button until the green indicator turns on and release, the device will be added automatically.

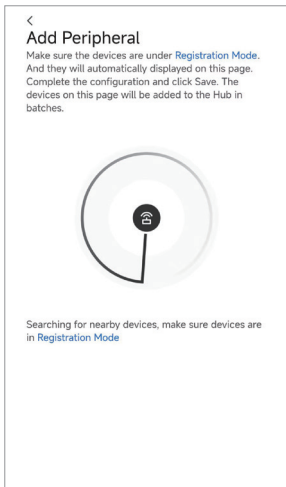
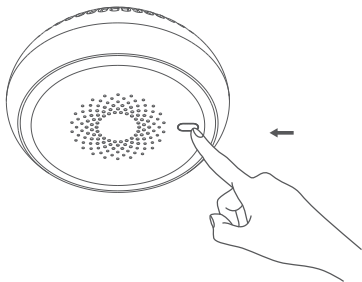

Add Smoke Detector

4 Assign a room and click the "Done" to finish adding.

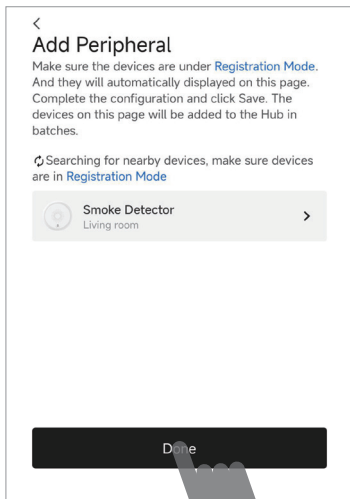

Installation Instruction

1 Mount on the ceiling by screws

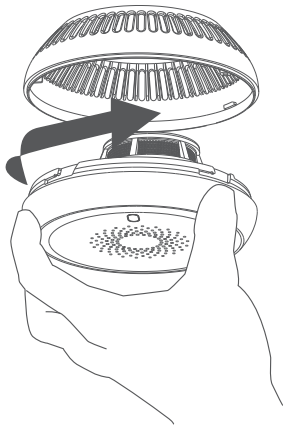
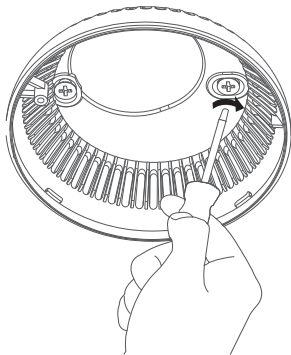

Installation Instruction

- 2 Mount on the ceiling by 3M adhesive strip

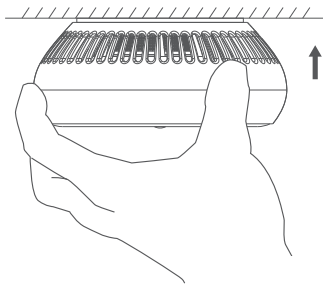
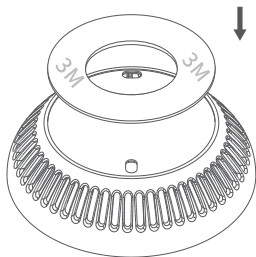

Device specifications

| Feature | |
|----------------------------|--|
| Alarm Buzzer | 80dB |
| LED Indicator | 1 |
| Tamper Protection | Rear |
| Wireless Transmission | |
| Transmission Frequency | 921MHz |
| Transmission Range | 1000m (Open Space) |
| Electrical Characteristics | |
| Standard Battery Life | CR123A × 1, Up to 2 years (standby mode) |
| General | |
| Operation Temperature | -10°C to 55°C (14 °F to 131 °F) |
| Dimensions (W x H x D) | 90mm x 90mm x 37mm |
| Mounting Method | Ceiling |
| Application Scenario | Indoor |
| Weight | 103.8g |

Powered by ***bluguard***[®]

 www.bluguard.com.my